

# TIPTOE

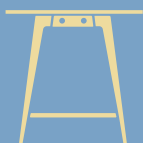
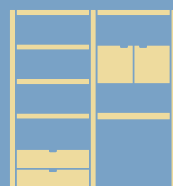
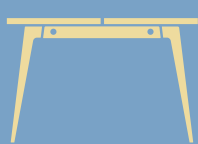

## 01 ABOUT THE BRAND

|   |    |
|---|----|
| A new standard for French design  | 08 |
| The design studio<br>Le studio de design  | 11 |
| Exceptional industrial know-how<br>Un savoir-faire industriel d'exception         | 12 |
| Social & environmental commitments<br>Nos engagements sociaux et environnementaux | 12 |
| Our 5 principles for sustainable design<br>Nos 5 principes pour un design durable | 15 |
| Retailer kit<br>Kit revendeurs  | 17 |
| Professional toolbox<br>Boîte à outils professionnelle                            | 17 |
| Tiptoe contract showroom & flagship store<br>Showroom contract & boutique Tiptoe  | 18 |

## 02 COLLECTIONS

|   |                                      |                      |
|---|--------------------------------------|----------------------|
| Exclusive edition<br>Edition exclusive          | Core Edition                         | 24                   |
| Table & desk<br>Table & bureau                  | Tiptoe<br>New Modern<br>Moka         | 30<br>40<br>44       |
| Chair, stool & bench<br>Chaise, tabouret & banc | SSD<br>SSD Full Wood<br>Lou<br>Etude | 48<br>52<br>54<br>56 |
| Shelving<br>Étagère                             | Bracket<br>Jo<br>Pli                 | 62<br>63<br>64       |
| Storage<br>Rangement                            | Unit system<br>Unit steel system     | 68<br>72             |
| Sofa<br>Canapé                                  | Easy<br>Bridge                       | 82<br>84             |
| Children furniture<br>Mobilier enfant           | Kids                                 | 90                   |
| Outdoor furniture<br>Mobilier extérieur         | Midi<br>Panorama<br>Moka             | 94<br>96<br>100      |
| Lighting<br>Luminaire                           | Nod                                  | 104                  |

## 03 FIND OUT MORE

|  |     |
|--|-----|
| Materials<br>Matériaux                     | 107 |
| Warranty & use rating<br>Garanties & usage | 110 |
| Certificates<br>Certificats                | 111 |
| Care guide<br>Entretien                    | 112 |
| Bespoke services<br>Services sur-mesure    | 118 |



METAL COLOR CHART  
 PALETTE DE COULEURS MÉTAL

INDOOR FURNITURE

TABLE LEG, TABLE, DESK, CHAIR, STOOL & BENCH

|   |  |   |
|---|--|---|
| Midnight blue<br>Bleu nuit<br>Nachtblau<br><br>RAL DSGN 240 30 10           | Khaki green<br>Vert kaki<br>Khakigrün<br><br>RAL 6013                | Brioche yellow<br>Jaune brioche<br>Briohegelb<br><br>RAL DSGN 080 80 60 |
| Graphite black<br>Noir graphite<br>Schwarz graphit<br><br>RAL 9011          | Eucalyptus grey<br>Gris eucalyptus<br>Eukalyptusgrau<br><br>RAL 7033 | Cream white<br>Blanc crème<br>Weiß creme<br><br>RAL 9001                |
| Tangerine red<br>Rouge tangerine<br>Tangerinenrot<br><br>RAL DSGN 050 50 40 | Pale blue<br>Bleu pâle<br>Blassblau<br><br>RAL DSGN 220 70 05        | Azure blue<br>Bleu azur<br>Azurblau<br><br>RAL DSGN 270 50 40           |
| Rock blue<br>Bleu roche<br>Felsblau<br><br>RAL 5014                         | Powder pink<br>Rose poudré<br>Puderrosa<br><br>RAL 3015              | Naples yellow<br>Jaune de Naples<br>Neapelgelb<br><br>RAL 1018          |

PLI SHELF

OUTDOOR FURNITURE

OUTDOOR TABLE, CHAIR, STOOL & BENCH

|  |  |   |
|--|--|---|
| Graphite black<br>Noir graphite<br>Schwarz graphit<br><br>RAL 9011 | Brick red<br>Rouge brique<br>Ziegelrot<br><br>RAL 8015 | Fir green<br>Vert forêt<br>Waldgrün<br><br>RAL 6009 |
| Sun yellow<br>Jaune soleil<br>Sonnengelb<br><br>RAL 1023           | Chalk grey<br>Gris craie<br>Kreidgrau<br><br>RAL 7044  |   |

# COLOR MATCHING CHART CORRESPONDANCE COULEURS

Indoor collections

Steel / Acier

Tinted wood  
Bois teinté

Table & desk / Table & bureau

Chair, stool & bench / Chaise, tabouret et banc

|  |                                 | Ra1 9011                       | Ra1 9001                  | Ra1 7033                          | Ra1 6013                | Ra1 dsgn 240 30 10        | Ra1 dsgn 270 50 40     | Ra1 dsgn 220 70 05    | Ra1 5014               | Ra1 3015                  | Ra1 dsgn 080 80 60             | Ra1 1018                        | Ra1 dsgn 050 50 40              | Ra1 5002              | Ra1 3003                     | Ra1 6005               |                             |  |
|--|---------------------------------|--------------------------------|---------------------------|-----------------------------------|-------------------------|---------------------------|------------------------|-----------------------|------------------------|---------------------------|--------------------------------|---------------------------------|---------------------------------|-----------------------|------------------------------|------------------------|-----------------------------|--|
|  |                                 | Graphite black / Noir graphite | Cream white / Blanc crème | Eucalyptus grey / Gris eucalyptus | Khaki green / Vert kaki | Midnight blue / Bleu nuit | Azure blue / Bleu azur | Pale blue / Bleu pâle | Rock blue / Bleu roche | Powder pink / Rose poudré | Brioche yellow / Jaune brioche | Naples yellow / Jaune de Naples | Tangerine red / Rouge tangerine | Royal Blue / Bleu roi | Poppy red / Rouge coquelicot | Fir green / Vert forêt | Natural oak / Chêne naturel | Brushed stainless steel / Inox brossé (CORE Edition) |
| <b>INDOOR COLLECTIONS</b>                |                                 |                                |                           |                                   |                         |                           |                        |                       |                        |                           |                                |                                 |                                 |                       |                              |                        |                             |  |
| <b>TIPTOE</b>                            |                                 |                                |                           |                                   |                         |                           |                        |                       |                        |                           |                                |                                 |                                 |                       |                              |                        |                             |  |
| Table leg / Pied de table                | 43cm / 16.9in                   |                                | •                         |                                   |                         |                           |                        |                       |                        |                           |                                |                                 |                                 |                       |                              |                        |                             |  |
|  | 50cm / 19.7in                   |                                | •                         |                                   |                         |                           |                        |                       |                        |                           |                                |                                 |                                 |                       |                              |                        |                             |  |
|  | 75cm / 29.5in                   |                                | •                         |                                   |                         |                           |                        |                       |                        |                           |                                |                                 |                                 |                       |                              |                        |                             |  |
|  | 90cm / 35.4in                   |                                | •                         |                                   |                         |                           |                        |                       |                        |                           |                                |                                 |                                 |                       |                              |                        |                             |  |
|  | 110cm / 43.3in                  |                                | •                         |                                   |                         |                           |                        |                       |                        |                           |                                |                                 |                                 |                       |                              |                        |                             |  |
| <b>NEW MODERN</b>                        |                                 |                                |                           |                                   |                         |                           |                        |                       |                        |                           |                                |                                 |                                 |                       |                              |                        |                             |  |
| Dining table / Table à manger            | Oak / Chêne                     |                                | •                         |                                   |                         |                           |                        |                       |                        |                           |                                |                                 |                                 |                       |                              |                        |                             |  |
|  | Old oak / Bois ancien           |                                | •                         |                                   |                         |                           |                        |                       |                        |                           |                                |                                 |                                 |                       |                              |                        |                             |  |
|  | «Venezia» recycled plastic      |                                | •                         |                                   |                         |                           |                        |                       |                        |                           |                                |                                 |                                 |                       |                              |                        |                             |  |
|  | White plywood / Stratifié blanc |                                | •                         |                                   |                         |                           |                        |                       |                        |                           |                                |                                 |                                 |                       |                              |                        |                             |  |
| Desk / Bureau                            | Oak / Chêne                     |                                | •                         |                                   |                         |                           |                        |                       |                        |                           |                                |                                 |                                 |                       |                              |                        |                             |  |
|  | «Venezia» recycled plastic      |                                | •                         |                                   |                         |                           |                        |                       |                        |                           |                                |                                 |                                 |                       |                              |                        |                             |  |
| High table / Table haute                 | Oak / Chêne                     |                                | •                         |                                   |                         |                           |                        |                       |                        |                           |                                |                                 |                                 |                       |                              |                        |                             |  |
| Workstation / Bureau open-space          | «Venezia» recycled plastic      |                                | •                         |                                   |                         |                           |                        |                       |                        |                           |                                |                                 |                                 |                       |                              |                        |                             |  |
|  | White plywood / Stratifié blanc |                                | •                         |                                   |                         |                           |                        |                       |                        |                           |                                |                                 |                                 |                       |                              |                        |                             |  |
| <b>MOKA</b> *Made to order               |                                 |                                |                           |                                   |                         |                           |                        |                       |                        |                           |                                |                                 |                                 |                       |                              |                        |                             |  |
| Coffee table / Table basse*              | Oak / Chêne                     |                                | •                         |                                   |                         |                           |                        |                       |                        |                           |                                |                                 |                                 |                       |                              |                        |                             |  |
| Bistro table / Table bistro              | Oak / Chêne                     |                                | •                         |                                   |                         |                           |                        |                       |                        |                           |                                |                                 |                                 |                       |                              |                        |                             |  |
|  | «Venezia» recycled plastic      |                                | •                         |                                   |                         |                           |                        |                       |                        |                           |                                |                                 |                                 |                       |                              |                        |                             |  |
| High table / Table haute*                | Oak / Chêne                     |                                | •                         |                                   |                         |                           |                        |                       |                        |                           |                                |                                 |                                 |                       |                              |                        |                             |  |
| <b>LOU</b>                               |                                 |                                |                           |                                   |                         |                           |                        |                       |                        |                           |                                |                                 |                                 |                       |                              |                        |                             |  |
| Stool / Tabouret                         | Oak / Chêne                     |                                | •                         |                                   |                         |                           |                        |                       |                        |                           |                                |                                 |                                 |                       |                              |                        |                             |  |
|  | Tinted oak / Chêne teinté       |                                | •                         |                                   |                         |                           |                        |                       |                        |                           |                                |                                 |                                 |                       |                              |                        |                             |  |
|  | Chroma Edition                  |                                | •                         |                                   |                         |                           |                        |                       |                        |                           |                                |                                 |                                 |                       |                              |                        |                             |  |
|  | «Venezia» recycled plastic      |                                | •                         |                                   |                         |                           |                        |                       |                        |                           |                                |                                 |                                 |                       |                              |                        |                             |  |
|  | «Macchiato» recycled plastic    |                                | •                         |                                   |                         |                           |                        |                       |                        |                           |                                |                                 |                                 |                       |                              |                        |                             |  |
| Bar stool / Tabouret de bar              | Oak / Chêne                     |                                | •                         |                                   |                         |                           |                        |                       |                        |                           |                                |                                 |                                 |                       |                              |                        |                             |  |
|  | Tinted oak / Chêne teinté       |                                | •                         |                                   |                         |                           |                        |                       |                        |                           |                                |                                 |                                 |                       |                              |                        |                             |  |
|  | «Venezia» recycled plastic      |                                | •                         |                                   |                         |                           |                        |                       |                        |                           |                                |                                 |                                 |                       |                              |                        |                             |  |
|  | «Macchiato» recycled plastic    |                                | •                         |                                   |                         |                           |                        |                       |                        |                           |                                |                                 |                                 |                       |                              |                        |                             |  |
| Bench / Banc                             | Oak / Chêne                     |                                | •                         |                                   |                         |                           |                        |                       |                        |                           |                                |                                 |                                 |                       |                              |                        |                             |  |
| <b>SSD</b>                               |                                 |                                |                           |                                   |                         |                           |                        |                       |                        |                           |                                |                                 |                                 |                       |                              |                        |                             |  |
| SSD chair / Chaise SSD                   | Oak / Chêne                     |                                | •                         |                                   |                         |                           |                        |                       |                        |                           |                                |                                 |                                 |                       |                              |                        |                             |  |
|  | Walnut / Noyer                  |                                | •                         |                                   |                         |                           |                        |                       |                        |                           |                                |                                 |                                 |                       |                              |                        |                             |  |
| SSDr chair / Chaise SSDr                 | Recycled plastic                |                                | •                         |                                   |                         |                           |                        |                       |                        |                           |                                |                                 |                                 |                       |                              |                        |                             |  |
| SSD soft chair / Chaise SSDr soft        | Oak / Chêne                     |                                | •                         |                                   |                         |                           |                        |                       |                        |                           |                                |                                 |                                 |                       |                              |                        |                             |  |
| SSD bar chair / Chaise de bar SSD        | Oak / Chêne                     |                                | •                         |                                   |                         |                           |                        |                       |                        |                           |                                |                                 |                                 |                       |                              |                        |                             |  |
| SSDr bar chair / Chaise de bar SSDr      | Recycled plastic                |                                | •                         |                                   |                         |                           |                        |                       |                        |                           |                                |                                 |                                 |                       |                              |                        |                             |  |
| SSD steel bar stool / Tab. bar SSD acier | Oak / Chêne                     |                                | •                         |                                   |                         |                           |                        |                       |                        |                           |                                |                                 |                                 |                       |                              |                        |                             |  |
| SSD FW chair / Chaise SSD FW             | Oak / Chêne                     |                                |                           |                                   |                         |                           |                        |                       |                        |                           |                                |                                 |                                 |                       |                              |                        |                             |  |
| SSD FW stool / Tabouret SSD FW           | Oak / Chêne                     |                                |                           |                                   |                         |                           |                        |                       |                        |                           |                                |                                 |                                 |                       |                              |                        |                             |  |
| SSD FW bar stool / Tab. bar SSD FW       | Oak / Chêne                     |                                |                           |                                   |                         |                           |                        |                       |                        |                           |                                |                                 |                                 |                       |                              |                        |                             |  |
| <b>ETUDE</b>                             |                                 |                                |                           |                                   |                         |                           |                        |                       |                        |                           |                                |                                 |                                 |                       |                              |                        |                             |  |
| Chair / Chaise                           | Oak / Chêne                     |                                | •                         |                                   |                         |                           |                        |                       |                        |                           |                                |                                 |                                 |                       |                              |                        |                             |  |
| Armrest chair / Chaise accoudoirs        | Oak / Chêne                     |                                | •                         |                                   |                         |                           |                        |                       |                        |                           |                                |                                 |                                 |                       |                              |                        |                             |  |
| Chair / Chaise                           | Monochrome                      |                                |                           |                                   |                         |                           |                        |                       |                        |                           |                                |                                 |                                 |                       |                              |                        |                             |  |
| Armrest chair / Chaise accoudoirs        | Monochrome                      |                                |                           |                                   |                         |                           |                        |                       |                        |                           |                                |                                 |                                 |                       |                              |                        |                             |  |
| Lounge chair / Chaise lounge             | Oak / Chêne                     |                                |                           |                                   |                         |                           |                        |                       |                        |                           |                                |                                 |                                 |                       |                              |                        |                             |  |
| Armrest lounge / Lounge accoudoirs       | Oak / Chêne                     |                                |                           |                                   |                         |                           |                        |                       |                        |                           |                                |                                 |                                 |                       |                              |                        |                             |  |

# COLOR MATCHING CHART CORRESPONDANCE COULEURS

Indoor collections

Steel / Acier

Tinted wood  
Bois teinté

Shelving / Étagère

Storage  
Rangement

|  |                            | Re1 9011                       | Re1 9001                  | Re1 7033                          | Re1 6013                | Re1 dsgn 240 30 10        | Re1 dsgn 270 50 40     | Re1 dsgn 220 70 05    | Re1 5014               | Re1 3015                  | Re1 dsgn 080 80 60             | Re1 1018                        | Re1 dsgn 050 50 40              | Re1 5002              | Re1 3003                     | Re1 6005               | Re1 6005                    | Brushed stainless steel / Inox brossé (COORE Edition) |
|--|----------------------------|--------------------------------|---------------------------|-----------------------------------|-------------------------|---------------------------|------------------------|-----------------------|------------------------|---------------------------|--------------------------------|---------------------------------|---------------------------------|-----------------------|------------------------------|------------------------|-----------------------------|---|
|  |                            | Graphite black / Noir graphite | Cream white / Blanc crème | Eucalyptus grey / Gris eucalyptus | Khaki green / Vert kaki | Midnight blue / Bleu nuit | Azure blue / Bleu azur | Pale blue / Bleu pâle | Rock blue / Bleu roche | Powder pink / Rose poudré | Brioche yellow / Jaune brioche | Naples yellow / Jaune de Naples | Tangerine red / Rouge tangerine | Royal Blue / Bleu roi | Poppy red / Rouge coquelicot | Fir green / Vert forêt | Natural oak / Chêne naturel |   |
| <b>BRACKET</b>                                   |                            |                                |                           |                                   |                         |                           |                        |                       |                        |                           |                                |                                 |                                 |                       |                              |                        |                             |   |
| Wall bracket / Accroche murale                   | Oak / Chêne                |                                | •                         |                                   |                         |                           |                        |                       |                        |                           |                                |                                 |                                 |                       |                              |                        |                             |   |
|  | Old oak / Bois ancien      |                                | •                         |                                   |                         |                           |                        |                       |                        |                           |                                |                                 |                                 |                       |                              |                        |                             |   |
|  | «Venezia» recycled plastic |                                | •                         |                                   |                         |                           |                        |                       |                        |                           |                                |                                 |                                 |                       |                              |                        |                             |   |
| <b>JO</b>  |                            |                                |                           |                                   |                         |                           |                        |                       |                        |                           |                                |                                 |                                 |                       |                              |                        |                             |   |
| Coat hooks / Porte-manteaux                      |                            |                                | •                         |                                   |                         |                           |                        |                       |                        |                           |                                |                                 |                                 |                       |                              |                        |                             |   |
| <b>PLI</b>                                       |                            |                                |                           |                                   |                         |                           |                        |                       |                        |                           |                                |                                 |                                 |                       |                              |                        |                             |   |
| Wall shelf / Étagère murale                      | 20cm / 7.9in               |                                | •                         |                                   |                         |                           |                        |                       |                        |                           |                                |                                 |                                 |                       |                              |                        |                             |   |
|  | 30cm / 11.8in              |                                | •                         |                                   |                         |                           |                        |                       |                        |                           |                                |                                 |                                 |                       |                              |                        |                             |   |
|  | 45cm / 17.7in              |                                | •                         |                                   |                         |                           |                        |                       |                        |                           |                                |                                 |                                 |                       |                              |                        |                             |   |
|  | 60cm / 23.6in              |                                | •                         |                                   |                         |                           |                        |                       |                        |                           |                                |                                 |                                 |                       |                              |                        |                             |   |
| Floating shelf / Tablette murale                 | 20cm / 7.9in               |                                | •                         |                                   |                         |                           |                        |                       |                        |                           |                                |                                 |                                 |                       |                              |                        |                             |   |
|  | 30cm / 11.8in              |                                | •                         |                                   |                         |                           |                        |                       |                        |                           |                                |                                 |                                 |                       |                              |                        |                             |   |
|  | 45cm / 17.7in              |                                | •                         |                                   |                         |                           |                        |                       |                        |                           |                                |                                 |                                 |                       |                              |                        |                             |   |
|  | 60cm / 23.6in              |                                | •                         |                                   |                         |                           |                        |                       |                        |                           |                                |                                 |                                 |                       |                              |                        |                             |   |
| Slim shelf / Étagère Slim                        | 20cm / 7.9in               |                                | •                         |                                   |                         |                           |                        |                       |                        |                           |                                |                                 |                                 |                       |                              |                        |                             |   |
|  | 30cm / 11.8in              |                                | •                         |                                   |                         |                           |                        |                       |                        |                           |                                |                                 |                                 |                       |                              |                        |                             |   |
|  | 45cm / 17.7in              |                                | •                         |                                   |                         |                           |                        |                       |                        |                           |                                |                                 |                                 |                       |                              |                        |                             |   |
|  | 60cm / 23.6in              |                                | •                         |                                   |                         |                           |                        |                       |                        |                           |                                |                                 |                                 |                       |                              |                        |                             |   |
| Hook add-on / Crochet*                           | 20cm / 7.9in               |                                | •                         |                                   |                         |                           |                        |                       |                        |                           |                                |                                 |                                 |                       |                              |                        |                             |   |
|  | 30cm / 11.8in              |                                | •                         |                                   |                         |                           |                        |                       |                        |                           |                                |                                 |                                 |                       |                              |                        |                             |   |
|  | 45cm / 17.7in              |                                | •                         |                                   |                         |                           |                        |                       |                        |                           |                                |                                 |                                 |                       |                              |                        |                             |   |
|  | 60cm / 23.6in              |                                | •                         |                                   |                         |                           |                        |                       |                        |                           |                                |                                 |                                 |                       |                              |                        |                             |   |
| *available on the wall shelf and slim wall shelf |                            |                                | •                         |                                   |                         |                           |                        |                       |                        |                           |                                |                                 |                                 |                       |                              |                        |                             |   |
| <b>UNIT SYSTEM</b>                               |                            |                                |                           |                                   |                         |                           |                        |                       |                        |                           |                                |                                 |                                 |                       |                              |                        |                             |   |
| UNIT   | Oak / Chêne                |                                | •                         |                                   |                         |                           |                        |                       |                        |                           |                                |                                 |                                 |                       |                              |                        |                             |   |
|  | Steel / Acier              |                                | •                         |                                   |                         |                           |                        |                       |                        |                           |                                |                                 |                                 |                       |                              |                        |                             |   |
| <b>NOD COLLECTION</b>                            |                            |                                |                           |                                   |                         |                           |                        |                       |                        |                           |                                |                                 |                                 |                       |                              |                        |                             |   |
| Table lamp / Lampe à poser                       |                            |                                | •                         |                                   |                         |                           |                        |                       |                        |                           |                                |                                 |                                 |                       |                              |                        |                             |   |

## COLOR MATCHING CHART CORRESPONDANCE COULEURS

### Outdoor collections

|                               |                                    | Graphite black / Noir graphite | Chalk grey / Gris craie | Fir green / Vert forêt | Brick red / Rouge brique | Sun yellow / Jaune soleil |
|-------------------------------|------------------------------------|--------------------------------|-------------------------|------------------------|--------------------------|---------------------------|
|                               |                                    | Ra1 9011                       | Ra1 7044                | Ra1 6009               | Ra1 8015                 | Ra1 1023                  |
| <b>OUTDOOR COLLECTIONS</b>    |                                    |                                |                         |                        |                          |                           |
| <b>MIDI</b>                   |                                    |                                |                         |                        |                          |                           |
| Table leg / Pied de table     | 75cm / 29.5in                      |                                |                         |                        |                          |                           |
| Dining table / Table à manger | 80x80cm / 31.5x31.5in              |                                |                         |                        |                          |                           |
|                               | 130x80cm / 51.2x31.5in             |                                |                         |                        |                          |                           |
|                               | 160x80cm / 63x31.5in               |                                |                         |                        |                          |                           |
|                               | 190x90cm / 74.8x35.5in             |                                |                         |                        |                          |                           |
| SSDr chair / Chaise SSDr      |                                    |                                |                         |                        |                          |                           |
| <b>PANORAMA</b>               |                                    |                                |                         |                        |                          |                           |
| Dining table / Table à manger | 90x90cm / 35.5x35.5in              |                                |                         |                        |                          |                           |
|                               | 130x90cm / 51.2x35.5in             |                                |                         |                        |                          |                           |
|                               | 160x90cm / 63x35.5in               |                                |                         |                        |                          |                           |
|                               | 190x90cm / 74.8x35.5in             |                                |                         |                        |                          |                           |
| Chair / Chaise                | With armrests / Avec accoudoirs    |                                |                         |                        |                          |                           |
|                               | Without armrests / Sans accoudoirs |                                |                         |                        |                          |                           |
| Lounge chair / Chaise lounge  | With armrests / Avec accoudoirs    |                                |                         |                        |                          |                           |
| Coffee table / Table basse    | 50x50cm / 19.7x19.7in              |                                |                         |                        |                          |                           |
| Bench / Banc                  | 140x90cm / 55.1x35.5in             |                                |                         |                        |                          |                           |
|                               | 170x90cm / 66.9x35.5in             |                                |                         |                        |                          |                           |
| Stool / Tabouret              |                                    |                                |                         |                        |                          |                           |
| <b>MOKA</b>                   |                                    |                                |                         |                        |                          |                           |
| Bistro table / Table bistro   | ø70cm / ø27.6in                    |                                |                         |                        |                          |                           |
|                               | 70x70cm / 27.6x27.6in              |                                |                         |                        |                          |                           |

## COLOR MATCHING CHART CORRESPONDANCE COULEURS

### Kids collection

|                                   |                                 | Cream white / Blanc crème | Whale blue / Bleu baleine | Dino green / Vert dino | Flamingo pink / Rose flamant | Sun yellow / Jaune soleil |
|-----------------------------------|---------------------------------|---------------------------|---------------------------|------------------------|------------------------------|---------------------------|
|                                   |                                 | Ra1 9001                  | Ra1 1023                  | Ra1 6019               | Ra1 3022                     | Ra1 1023                  |
| <b>KIDS COLLECTION</b>            |                                 |                           |                           |                        |                              |                           |
| Table leg / Pied de table         | 50cm / 19.7in                   | •                         |                           |                        |                              |                           |
| Table top / Plateau               | Oak / Chêne                     | •                         |                           |                        |                              |                           |
|                                   | Blackboard / Ardoise            | •                         |                           |                        |                              |                           |
|                                   | «Tutti Frutti» recycled plastic | •                         |                           |                        |                              |                           |
| Stool / Tabouret<br>30cm / 11.8in | Oak / Chêne                     | •                         |                           |                        |                              |                           |
|                                   | «Tutti Frutti» recycled plastic | •                         |                           |                        |                              |                           |

# COLOR MATCHING CHART CORRESPONDANCE COULEURS

Fabric / Tissu

Gabriel

Rohi

|   |                                | Carbon black / Noir charbon<br>CYBER 3101 | Sand beige / Beige sable<br>CYBER 1101 | Slate grey / Gris ardoise<br>CURA 60019 | Sand beige / Beige sable<br>CURA 61168 | Midnight blue / Bleu nuit<br>CURA 66165 | Forest green / Vert forêt<br>CURA 68182 | Heather grey / Gris chiné<br>CHILLI 60114 | Vintage pink / Rose chiné<br>CHILLI 63092 | Slate grey / Gris ardoise<br>ARCO IANOSO | Ice grey / Gris glacier<br>ARCO ICE | Ivory beige / Beige ivoire<br>ARCO ARCTIC | Ink blue / Bleu encre<br>ARCO INK | Snow white / Blanc neige<br>ARCO SNOW | Forest green / Vert forêt<br>ARCO FOREST | Lemon yellow / Jaune citron<br>ARCO CITRON |
|---|--------------------------------|---|--|---|--|---|---|---|---|--|-------------------------------------|---|-----------------------------------|---------------------------------------|--|--|
| <b>FABRIC / TISSU</b>                             |                                |   |  |   |  |   |   |   |   |  |                                     |   |                                   |                                       |  |  |
| <b>EASY SOFA</b>                                  |                                |   |  |   |  |   |   |   |   |  |                                     |   |                                   |                                       |  |  |
| 2 seater / 2 places                               | Graphite black / Noir graphite |   |  |   |  |   |   |   |   |  |                                     |   |                                   |                                       |  |  |
| 3/4 seater / 3/4 places                           | Graphite black / Noir graphite |   |  |   |  |   |   |   |   |  |                                     |   |                                   |                                       |  |  |
| Ottoman   | Graphite black / Noir graphite |   |  |   |  |   |   |   |   |  |                                     |   |                                   |                                       |  |  |
| <b>BRIDGE SOFA*</b> <small>*Made to order</small> |                                |   |  |   |  |   |   |   |   |  |                                     |   |                                   |                                       |  |  |
| Center seat / Module central*                     |                                |   |  |   |  |   |   |   |   |  |                                     |   |                                   |                                       |  |  |
| Corner seat / Module d'angle*                     |                                |   |  |   |  |   |   |   |   |  |                                     |   |                                   |                                       |  |  |
| Ottoman*  |                                |   |  |   |  |   |   |   |   |  |                                     |   |                                   |                                       |  |  |
| <b>ETUDE CHAIR</b>                                |                                |   |  |   |  |   |   |   |   |  |                                     |   |                                   |                                       |  |  |
| Chair / Chaise                                    | Cream white / Blanc crème      |   |  |   |  |   |   |   |   |  |                                     |   |                                   |                                       |  |  |
| Chair / Chaise                                    | Graphite black / Noir graphite |   |  |   |  |   |   |   |   |  |                                     |   |                                   |                                       |  |  |
| Armrest chair / Chaise accoudoirs                 | Cream white / Blanc crème      |   |  |   |  |   |   |   |   |  |                                     |   |                                   |                                       |  |  |
| Armrest chair / Chaise accoudoirs                 | Graphite black / Noir graphite |   |  |   |  |   |   |   |   |  |                                     |   |                                   |                                       |  |  |
| Armrest lounge / Lounge accoudoirs                | Graphite black / Noir graphite |   |  |   |  |   |   |   |   |  |                                     |   |                                   |                                       |  |  |
| <b>SSD SOFT CHAIR</b>                             |                                |   |  |   |  |   |   |   |   |  |                                     |   |                                   |                                       |  |  |
| Chair / Chaise                                    | Graphite black / Noir graphite |   |  |   |  |   |   |   |   |  |                                     |   |                                   |                                       |  |  |
|   | Cream white / Blanc crème      |   |  |   |  |   |   |   |   |  |                                     |   |                                   |                                       |  |  |

# A NEW STANDARD FOR FRENCH DESIGN



**This vision reflects the way Tiptoe designs and crafts each product.**

Cette vision reflète la façon dont Tiptoe pense et fabrique chaque objet.

Since its creation in 2015, Tiptoe has been infusing the French design landscape with a new vision. Year after year, the studio has set itself apart with a highly distinctive approach to product design. Its vision is driven by an exceptional industrial expertise in service of creative and innovative concepts. Tiptoe stands out for its timeless design, a bold take on color and an uncompromising (yet unfinished) work for the best use of materials. As a design studio, Tiptoe aims to make a lasting positive impact on French design.

Depuis sa création en 2015, Tiptoe insufflé une vision nouvelle dans le paysage du design français. Année après année, le studio a su se distinguer par une approche singulière du design d'objet. Sa vision repose sur un savoir-faire industriel d'exception au service d'un design créatif et innovant. Tiptoe se démarque par son design intemporel, une approche audacieuse de la couleur et un travail rigoureux (bien qu'en constante évolution) pour une utilisation optimale des matériaux. En tant que studio de design, Tiptoe vise à avoir un impact positif et durable sur le design français.

**Each product is designed in Paris and manufactured in Europe.**

Chaque objet est dessiné à Paris et fabriqué en Europe.



## THE DESIGN STUDIO LE STUDIO DE DESIGN

Driven by a rigorous manufacturing culture, we deliver beautiful, useful and timeless products that can stand the test of time. Our expertise relies on high-precision industrial processes in support of creative and innovative designs.

Our designers are constantly searching for bold colors and the best use of materials. By designing interchangeable and easy-to-replace elements, their approach goes beyond the minimal and functional aspects of product development. The thoroughness of their work guarantees each product a very long lifetime along with extraordinary reparability.

The studio celebrates the founding principles established by leading figures of French design from the mid-20<sup>th</sup> century. In doing so, Tiptoe has developed its own design standards based on industrial expertise, uncompromising sustainability and timeless aesthetics.

Portés par une culture exigeante de la fabrication, nous concevons des objets beaux, utiles, intemporels et capables de résister à l'épreuve du temps. Notre savoir-faire repose sur des procédés industriels précis au service d'un design créatif et innovant. Nos designers sont en constante recherche de couleurs audacieuses et du meilleur usage des matériaux. En pensant des éléments interchangeables et remplaçables, leur approche ne s'arrête pas à l'aspect minimal et fonctionnel de la conception. Ce travail rigoureux garantit une durée de vie longue à nos objets.

Le studio célèbre les principes fondateurs établis par les grandes figures du design français du milieu du XX<sup>e</sup> siècle. Ce faisant, Tiptoe a développé ses propres standards de design basés sur une excellence industrielle, une durabilité sans compromis et une esthétique intemporelle.

Our vision of  
product design  
is deeply modern  
and vibrant.

Notre vision du  
design d'objet  
est résolument  
moderne et vivante.



**EXCEPTIONAL  
INDUSTRIAL KNOW-HOW  
UN SAVOIR-FAIRE  
INDUSTRIEL D'EXCEPTION**

From the very start, Tiptoe has insisted on 100% European manufacturing relying on our partners' unique expertise in the work of wood, metal and recycled plastic. This commitment to high-quality manufacturing stems from Matthieu Bourgeaux's family history. Specializing in a precision technique called bar turning, the family workshop based in France in Haute-Savoie has been a key industrial partner for nearly 10 years. This craftsmanship culture fosters a pro-active approach to the exploration of new materials (especially recycled ones) and production methods to guarantee the sustainability of our products.

Dès ses débuts, Tiptoe a fait le choix d'une production 100% européenne qui s'appuie sur le savoir-faire d'excellence de partenaires travaillant le bois, le métal ou encore le plastique recyclé. Cette exigence pour une fabrication de grande qualité trouve son ancrage dans l'histoire familiale de Matthieu Bourgeaux. Spécialisé dans l'usinage de précision du métal (le décolletage), l'atelier familial situé en Haute-Savoie est l'un des principaux partenaires industriels de la marque depuis près de 10 ans. Cette culture de la fabrication nourrit une démarche active dans l'exploration de nouveaux matériaux (recyclés notamment) et de modes de fabrication afin de garantir la durabilité de nos produits.



**SOCIAL & ENVIRONMENTAL  
COMMITMENTS  
NOS ENGAGEMENTS SOCIAUX  
& ENVIRONNEMENTAUX**

As a mission-driven company, Tiptoe is a pioneer in eco-design in the furniture sector. Beyond its 100% European production and the exceptionally long life of its products, the studio's efforts include the use of circular and recycled materials in the manufacture of its products. Tiptoe is also multiplying circular initiatives like the «RESTORE» program, which gives a second life to its products, or the extended availability of spare parts.

Entreprise à mission, Tiptoe est une marque pionnière en matière d'éco-conception dans le secteur du mobilier. En complément d'une fabrication 100% européenne et de produits à la durée de vie exceptionnelle, l'engagement du studio passe notamment par l'emploi de matériaux circulaires et recyclés dans la fabrication de ses produits. En parallèle, Tiptoe multiplie les initiatives circulaires comme le programme «RESTORE» qui offre une seconde vie à ses produits ou la mise à disposition élargie de pièces détachées.







**OUR 5 PRINCIPLES FOR  
SUSTAINABLE DESIGN**  
NOS 5 PRINCIPES POUR  
UN DESIGN DURABLE

- 01 Make things simple**  
Créer des objets simples  
  
We focus on simplicity while removing anything unnecessary.  
Nous privilégions la simplicité en éliminant tout ce qui est superflu.
  
- 02 Make more with less**  
Faire beaucoup avec peu  
  
Our designs are resource-efficient and driven by high functionality.  
Nous concevons des produits fonctionnels, avec une utilisation efficace des ressources.
  
- 03 Use the right materials**  
Utiliser les bons matériaux  
  
Our materials are durable, well-sourced, easy-to-recycle or already recycled. Always resistant.  
Nos matériaux sont durables, bien sourcés, faciles à recycler ou déjà recyclés. Toujours résistants.
  
- 04 Build to last**  
Créer pour durer  
  
We make robust products that will stand the test of time.  
Nous créons des produits robustes qui résistent à l'épreuve du temps.
  
- 05 Design for disassembly**  
Penser la déconstruction  
  
Thanks to component-based design principles, all our products are easy-to-repair and easy-to-recycle.  
Tous nos produits sont constitués d'un nombre limité de pièces, toutes essentielles et interchangeables, afin de faciliter la réparation et le recyclage.



## RETAILER KIT KIT REVENDEUR

Tiptoe has developed several tools to support its partners in the brand's implementation. A Welcome Pack, including the material library and catalogs, is sent by mail. In addition, a POS and merchandising kit has been created to ensure clear visual and physical identification of Tiptoe in retail locations. Access to the digital showroom also allows for an online presentation of the full product range. Finally, a dedicated team for customer service and sales support is available to provide personalized assistance, addressing any inquiries related to order tracking, stock management, and much more.

Tiptoe a développé plusieurs outils pour accompagner ses partenaires dans l'implantation de la marque. Un Welcome Pack, comprenant la matériauthèque et les catalogues, est envoyé par voie postale. De plus, un kit PLV et merchandising a été conçu pour assurer une identification visuelle et physique de Tiptoe dans les points de vente. L'accès au showroom digital permet également une présentation en ligne complète de l'ensemble des produits. Enfin, une équipe dédiée à l'ADV et à la relation commerciale est disponible pour offrir un support personnalisé, répondant à toutes les demandes liées au suivi des commandes, à la gestion des stocks et bien plus encore.

## PROFESSIONAL TOOLBOX BOÎTE À OUTILS PROFESSIONNELLE



Scan to access  
the digital library

The digital library brings together all the essential resources for Tiptoe products: images, 3D files, videos, catalogues and certifications. Tiptoe products are available in pCon.planner ME (free version), pCon.planner PRO and pCon Basket, allowing you to design detailed 3D layouts quickly and efficiently.

La bibliothèque digitale regroupe l'ensemble des ressources essentielles autour des produits Tiptoe : images, fichiers 3D, vidéos, catalogues et certifications. Pour concevoir rapidement des plans d'aménagement 3D précis, les objets Tiptoe sont disponibles sur pCon.planner ME (édition gratuite), pCon.planner PRO et pCon Basket.

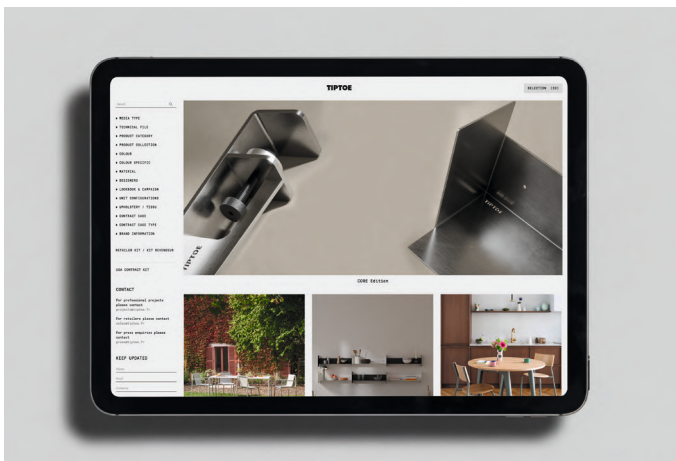

[tiptoe.presscloud.com](http://tiptoe.presscloud.com)

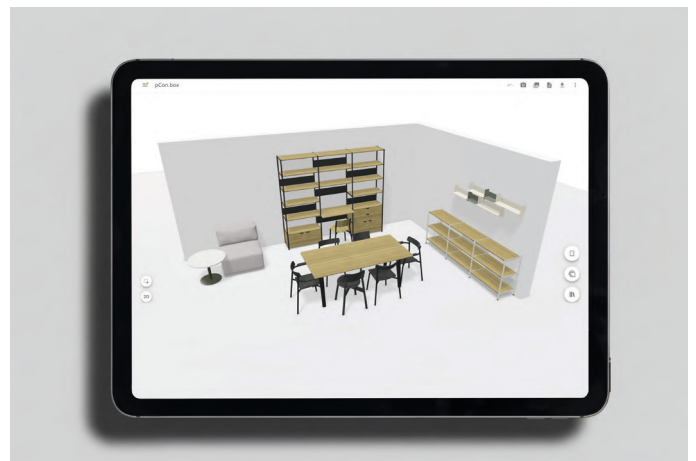

[pCon.planner](http://pCon.planner)

**TIPTOE CONTRACT SHOWROOM  
& FLAGSHIP STORE**  
SHOWROOM CONTRACT  
& BOUTIQUE TIPTOE

Our contract showroom is located in Paris, in the 10<sup>th</sup> district, and is open from Monday to Friday, from 10am to 6pm by appointment. Our flagship store is located in the heart of Paris' 1<sup>st</sup> arrondissement, a stone's throw from Place des Victoires.

Notre showroom contract se situe à Paris, dans le 10<sup>e</sup> arrondissement, et est ouvert du lundi au vendredi, de 10h à 18h sur rendez-vous. Notre boutique est située au cœur du 1<sup>er</sup> arrondissement de Paris, à deux pas de la Place des Victoires.



Tiptoe flagship store  
49 rue Étienne Marcel  
75001, Paris





Tiptoe contract showroom  
46 rue du Faubourg Saint-Martin  
75010, Paris



Tiptoe products are also on display in the FERMOB showrooms listed below:

Les produits Tiptoe sont également présentés dans les showrooms FERMOB ci-dessous :

La maison FERMOB  
57 chemin des Jonchères,  
71850, Charnay-lès-Mâcon

FERMOB Germany  
Neumarkt 49,  
50667, Köln

CORE EXCLUSIVE EDITION

---



Table leg  
75cm / 29.5in



Table leg  
43cm / 16.9in



Lou stool



Bracket wall shelf



Pli wall shelf



Pli Slim wall shelf



Pli coat hook add-on



**CORE EXCLUSIVE EDITION**  
**EDITION EXCLUSIVE CORE**



**CORE EDITION**  
by Tiptoe studio

North America use rating

Tiptoe table legs

RESIDENTIAL •

Lou stool & Bracket wall shelf

RESIDENTIAL •

CONTRACT •

**Tiptoe table leg - 75cm / 29.5in**  
Pied de table Tiptoe - 75cm



**MATERIALS / MATÉRIAUX**  
Stainless steel / Acier inoxydable  
Steel / Acier  
Aluminium

**MANUFACTURING / ORIGINES**  
Made in Europe  
Metal parts : Lithuania, France

**DIMENSIONS**



(B) Width / Largeur : 6cm / 2.4in  
(C) Height / Hauteur : 75cm / 29.5in

**WEIGHT / POIDS**  
2,5kg / 5,5lbs

**SPECIFICATIONS / SPÉCIFICITÉS**  
Flat pack / Livraison à plat

**ECO IMPACT SCORE**  
Not rated yet / Non évalué à date

**Tiptoe table leg - 43cm / 16.9in\***  
Pied de table Tiptoe - 43cm



**MATERIALS / MATÉRIAUX**  
Stainless steel / Acier inoxydable  
Steel / Acier  
Aluminium

**MANUFACTURING / ORIGINES**  
Made in Europe  
Metal parts : Lithuania, France

**DIMENSIONS**



(B) Width / Largeur : 6cm / 2.4in  
(C) Height / Hauteur : 43cm / 16.9in

**WEIGHT / POIDS**  
1kg / 2,20lbs

**SPECIFICATIONS / SPÉCIFICITÉS**  
Flat pack / Livraison à plat

**ECO IMPACT SCORE**  
Not rated yet / Non évalué à date

**Lou stool**  
Tabouret Lou



**MATERIALS / MATÉRIAUX**  
Solid oak / Chêne massif  
Stainless steel / Acier inoxydable

**MANUFACTURING / ORIGINES**  
Made in Europe  
Metal parts : France  
Wood : Czech Republic

**DIMENSIONS**

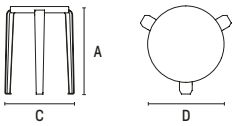

(A) Height / Hauteur : 45cm / 17.7in  
(C) Floor space / Emprise au sol : 35,6x30cm / 13.8x11.8in  
(D) Seat diameter / Diamètre d'assise : ø30cm / ø11.8in

**SPECIFICATIONS / SPÉCIFICITÉS**

Flat pack / Livraison à plat  
Max user load / Poids max utilisateur : 120kg / 275lbs  
Stackable / Empilable : 7

**ECO IMPACT SCORE**

Not rated yet / Non évalué à date

**Bracket wall shelf**  
Accroche murale Bracket



**MATERIALS / MATÉRIAUX**  
Stainless steel / Acier inoxydable  
Steel / Acier  
Aluminium

**MANUFACTURING / ORIGINES**  
Made in Europe  
Metal parts : France

**DIMENSIONS**

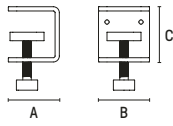

(A) Length / Longueur : 6cm / 2.4in  
(B) Width / Largeur : 6cm / 2.4in  
(C) Height / Hauteur : 6,5cm / 2.4in

**SPECIFICATIONS / SPÉCIFICITÉS**

Flat pack / Livraison à plat  
Maximum load / Charge maximale : 7kg / 15,4lbs

**ECO IMPACT SCORE**

Not rated yet / Non évalué à date

**CORE EDITION**  
by Tiptoe studio

North America use rating

|             |   |
|-------------|---|
| RESIDENTIAL | • |
| CONTRACT    | • |

**Pli wall shelf**  
Étagère murale Pli



**MATERIALS / MATÉRIAUX**  
Stainless steel / Acier inoxydable

**MANUFACTURING / ORIGINES**  
Made in Europe  
Metal parts : France

**DIMENSIONS**

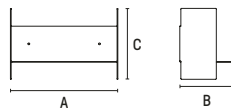

(A) Length / Longueur : 20cm / 7.9in  
(B) Width / Largeur : 15cm / 5.9in  
(C) Height / Hauteur : 20cm / 7.9in

(A) Length / Longueur : 30cm / 11.8in  
(B) Width / Largeur : 15cm / 5.9in  
(C) Height / Hauteur : 20cm / 7.9in

(A) Length / Longueur : 45cm / 17.7in  
(B) Width / Largeur : 15cm / 5.9in  
(C) Height / Hauteur : 20cm / 7.9in

(A) Length / Longueur : 60cm / 23.6in  
(B) Width / Largeur : 15cm / 5.9in  
(C) Height / Hauteur : 20cm / 7.9in

**SPECIFICATIONS / SPÉCIFICITÉS**  
Not flat pack / Non livré à plat  
Maximum load / Charge maximale : 15kg / 33lbs

**ECO IMPACT SCORE**  
Not rated yet / Non évalué à date

**Pli Slim wall shelf**  
Étagère murale Slim Pli



**MATERIALS / MATÉRIAUX**  
Stainless steel / Acier inoxydable

**MANUFACTURING / ORIGINES**  
Made in Europe  
Metal parts : France

**DIMENSIONS**

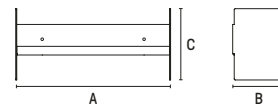

(A) Length / Longueur : 20cm / 7.9in  
(B) Width / Largeur : 10cm / 3.9in  
(C) Height / Hauteur : 14cm / 5.5in

(A) Length / Longueur : 30cm / 11.8in  
(B) Width / Largeur : 10cm / 3.9in  
(C) Height / Hauteur : 14cm / 5.5in

(A) Length / Longueur : 45cm / 17.7in  
(B) Width / Largeur : 10cm / 3.9in  
(C) Height / Hauteur : 14cm / 5.5in

(A) Length / Longueur : 60cm / 23.6in  
(B) Width / Largeur : 10cm / 3.9in  
(C) Height / Hauteur : 14cm / 5.5in

**SPECIFICATIONS / SPÉCIFICITÉS**  
Not flat pack / Non livré à plat  
Maximum load / Charge maximale : 10kg / 22lbs

**ECO IMPACT SCORE**  
Not rated yet / Non évalué à date

## Pli coat hook add-on\*

Crochet pour étagère Pli

\*Add on for wall shelf and Slim wall shelf  
Crochet disponible pour l'étagère Pli et Pli Slim



**MATERIALS / MATÉRIAUX**  
Stainless steel / Acier inoxydable

**MANUFACTURING / ORIGINES**  
Made in Europe  
Metal parts : France

### DIMENSIONS

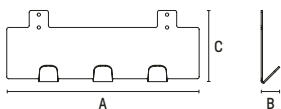

(A) Length / Longueur : 20cm / 7.9in  
(B) Width / Largeur : 3cm / 1.2in  
(C) Height / Hauteur : 10cm / 3.9in

(A) Length / Longueur : 30cm / 11.8in  
(B) Width / Largeur : 3cm / 1.2in  
(C) Height / Hauteur : 10cm / 3.9in

(A) Length / Longueur : 45cm / 17.7in  
(B) Width / Largeur : 3cm / 1.2in  
(C) Height / Hauteur : 10cm / 3.9in

(A) Length / Longueur : 60cm / 23.6in  
(B) Width / Largeur : 3cm / 1.2in  
(C) Height / Hauteur : 10cm / 3.9in

**SPECIFICATIONS / SPÉCIFICITÉS**  
Not flat pack / Non livré à plat  
Maximum load / Charge maximale : 10kg / 22lbs

**ECO IMPACT SCORE**  
Not rated yet / Non évalué à date

**WALL-MOUNTED COAT RACK**  
ÉTAGÈRE PORTE-MANTEAU



TIPTOE COLLECTION

BESPOKE OPTIONS AVAILABLE  
SUR-MESURE DISPONIBLE 

\*Product not available for the US market



Table leg  
75cm / 29.5in



Dining table



Side table



Desk



Table leg & wall bracket  
75cm / 29.5in



Wall-mounted dining table



Desk



Table leg & wall bracket  
90cm / 35.4in



Wall-mounted dining table



Table leg & wall bracket  
110cm / 43.3in



Wall-mounted dining table



Table leg\*  
43cm / 16.9in



Occasional bench\*



Coffee table\*

NEW MODERN LIVING COLLECTION

NEW MODERN WORKING COLLECTION

BESPOKE OPTIONS AVAILABLE  
SUR-MESURE DISPONIBLE 



Dining table



Dining table



Desk



High table



Workstation



Meeting table

MOKA COLLECTION

BESPOKE OPTIONS AVAILABLE  
SUR-MESURE DISPONIBLE 



\*Made to order  
Coffee table\*



Bistro table



\*Made to order  
High table\*

# TABLE & DESK TABLE & BUREAU



**TIPTOE COLLECTION**  
by Tiptoe studio

North America use rating

RESIDENTIAL

| TABLE LEG<br>PIED DE TABLE         | HEIGHT<br>HAUTEUR |
|------------------------------------|-------------------|
| Graphite black<br>Noir graphite    | 75cm / 29.5in     |
| Cream white<br>Blanc crème         |                   |
| Eucalyptus grey<br>Gris eucalyptus |                   |
| Khaki green<br>Vert kaki           |                   |
| Midnight blue<br>Bleu nuit         |                   |
| Azure blue<br>Bleu azur            |                   |
| Pale blue<br>Bleu pâle             |                   |
| Brioche yellow<br>Jaune brioche    |                   |
| Tangerine red<br>Rouge tangerine   |                   |

| TABLE TOP<br>PLATEAU   | SIZE<br>TAILLE   |
|------------------------|--|
| Oak<br>Chêne           | 120x60cm / 47.2x23.6in<br>120x30cm / 47.2x11.8in<br>150x75cm / 59.1x29.5in<br>180x90cm / 70.9x35.4in |
| Old oak<br>Bois ancien |  |

TABLE TOP THICKNESS / ÉPAISSEUR PLATEAU  
Oak / Chêne : 4cm / 1.6in  
Old oak / Bois ancien : 4cm / 1.6in

**Tiptoe table leg - 75cm / 29.5in**  
Pied de table Tiptoe - 75cm



MATERIALS / MATÉRIAUX  
Steel / Acier  
Aluminium  
MANUFACTURING / ORIGINES  
Made in Europe  
Metal parts : Lithuania, France

**DIMENSIONS**

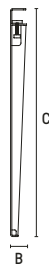

(B) Width / Largeur : 6cm / 2.4in  
(C) Height / Hauteur : 75cm / 29.5in

WEIGHT / POIDS  
2,5kg / 5.5lbs

SPECIFICATIONS / SPÉCIFICITÉS  
Flat pack / Livraison à plat

ECO IMPACT SCORE



**Dining table**  
Table à manger



MATERIALS / MATÉRIAUX  
Steel / Acier  
Aluminium  
Tabletop options :  
Oak veneered plywood «Oak» / Contreplaqué plaqué chêne «Chêne»  
Solid oak «Old oak» / Chêne massif «Bois ancien»  
MANUFACTURING / ORIGINES  
Made in Europe  
Metal parts : Lithuania, France  
Wood : Croatia, Bosnia

**DIMENSIONS**

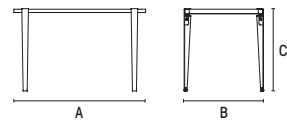

(A) Length / Longueur : 120cm / 47.2in  
(B) Width / Largeur : 60cm / 23.6in  
(C) Height / Hauteur : 75cm / 29.5in

(A) Length / Longueur : 150cm / 59.1in  
(B) Width / Largeur : 75cm / 29.5in  
(C) Height / Hauteur : 75cm / 29.5in

(A) Length / Longueur : 180cm / 70.9in  
(B) Width / Largeur : 90cm / 35.4in  
(C) Height / Hauteur : 75cm / 29.5in

SPECIFICATIONS / SPÉCIFICITÉS  
Flat pack / Livraison à plat  
Max table top weight / Poids max plateau : 70kg / 154.3lbs

ECO IMPACT SCORE



● ● ● 120x60cm / 47.2x23.6in

**Side table**  
Console



**MATERIALS / MATÉRIAUX**  
Steel / Acier  
Aluminium  
Tabletop options :  
Solid oak «Oak» / Chêne massif «Chêne»  
Solid oak «Old oak» / Chêne massif «Bois ancien»

**MANUFACTURING / ORIGINES**  
Made in Europe  
Metal parts : Lithuania, France  
Wood : Croatia, Bosnia

**DIMENSIONS**

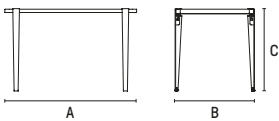

(A) Length / Longueur : 120cm / 47.2in  
(B) Width / Largeur : 30cm / 11.8in  
(C) Height / Hauteur : 75cm / 29.5in

**SPECIFICATIONS / SPÉCIFICITÉS**

Flat pack / Livraison à plat  
Max table top weight / Poids max plateau : 70kg / 154.31bs

**ECO IMPACT SCORE**



**Desk & drawer unit**  
Bureau & bloc de rangement



**MATERIALS / MATÉRIAUX**  
Steel / Acier  
Aluminium  
Tabletop options :  
Oak veneered plywood «Oak» / Contreplaqué plaqué chêne «Chêne»  
Solid oak «Old oak» / Chêne massif «Bois ancien»

**MANUFACTURING / ORIGINES**  
Made in Europe  
Metal parts : Lithuania, France  
Wood : Croatia, Bosnia

**DIMENSIONS**

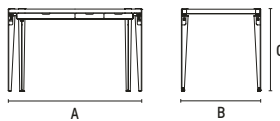

(A) Length / Longueur : 120cm / 47.2in  
(B) Width / Largeur : 60cm / 23.6in  
(C) Height / Hauteur : 75cm / 29.5in

**SPECIFICATIONS / SPÉCIFICITÉS**

Flat pack / Livraison à plat  
Max table top weight / Poids max plateau : 70kg / 154.31bs

**ECO IMPACT SCORE**



**Drawer unit**  
Bloc de rangement



**MATERIALS / MATÉRIAUX**  
Steel / Acier

**MANUFACTURING / ORIGINES**  
France

**COLORS / COULEURS**  
Graphite black / Noir graphite  
Cream white / Blanc crème  
Eucalyptus grey / Gris eucalyptus



**DIMENSIONS**

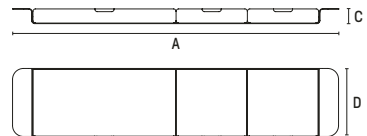

(A) Length / Longueur : 110cm / 43.3in  
(C) Height / Hauteur : 7cm / 2.8in  
(D) Depth / Profondeur : 25cm / 9.8in

**SPECIFICATIONS / SPÉCIFICITÉS**

Flat pack / Livraison à plat

**ECO IMPACT SCORE**

Not rated yet / Non évalué à date

**TIPTOE COLLECTION**  
by Tiptoe studio

North America use rating

RESIDENTIAL

| TABLE LEG<br>PIED DE TABLE         | HEIGHT<br>HAUTEUR |
|------------------------------------|-------------------|
|                                    | 75cm / 29.5in     |
| Graphite black<br>Noir graphite    | ● ●               |
| Cream white<br>Blanc crème         | ○ ●               |
| Eucalyptus grey<br>Gris eucalyptus | ● ●               |
| Khaki green<br>Vert kaki           | ● ●               |
| Midnight blue<br>Bleu nuit         | ● ●               |
| Azure blue<br>Bleu azur            | ● ●               |
| Pale blue<br>Bleu pâle             | ● ●               |
| Brioche yellow<br>Jaune brioche    | ● ●               |
| Tangerine red<br>Rouge tangerine   | ● ●               |

| TABLE TOP<br>PLATEAU   | SIZE<br>TAILLE                                   |
|------------------------|--|
|                        | 120x60cm / 47.2x23.6in<br>150x75cm / 59.1x29.5in |
| Oak<br>Chêne           | ● ●  |
| Old oak<br>Bois ancien | ● ●  |

TABLE TOP THICKNESS / ÉPAISSEUR PLATEAU  
Oak / Chêne : 4cm / 1.6in  
Old oak / Bois ancien : 4cm / 1.6in

**Tiptoe table leg - 75cm / 29.5in**  
& wall Bracket  
Pied de table Tiptoe - 75cm  
& accroche murale Bracket



MATERIALS / MATÉRIAUX  
Steel / Acier  
Aluminium  
MANUFACTURING / ORIGINES  
Made in Europe  
Metal parts : Lithuania, France

**DIMENSIONS**

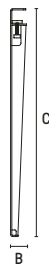

(B) Width / Largeur : 6cm / 2.4in  
(C) Height / Hauteur : 75cm / 29.5in

WEIGHT / POIDS  
2,5kg / 5.5lbs

SPECIFICATIONS / SPÉCIFICITÉS  
Flat pack / Livraison à plat

**ECO IMPACT SCORE**



**Wall-mounted dining table**  
Table à manger murale



MATERIALS / MATÉRIAUX  
Steel / Acier  
Aluminium  
Tabletop options :  
Oak veneered plywood «Oak» / Contreplaqué plaqué chêne «Chêne»  
Solid oak «Old oak» / Chêne massif «Bois ancien»  
MANUFACTURING / ORIGINES  
Made in Europe  
Metal parts : Lithuania, France, Bulgaria  
Wood : Croatia, Bosnia

**DIMENSIONS**

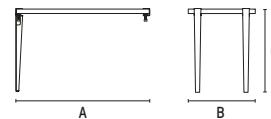

(A) Length / Longueur : 120cm / 47.2in  
(B) Width / Largeur : 60cm / 23.6in  
(C) Height / Hauteur : 75cm / 29.5in

(A) Length / Longueur : 150cm / 59.1in  
(B) Width / Largeur : 75cm / 29.5in  
(C) Height / Hauteur : 75cm / 29.5in

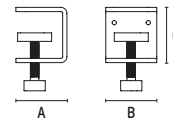

(A) Length / Longueur : 6cm / 2.4in  
(B) Width / Largeur : 6cm / 2.4in  
(C) Height / Hauteur : 6,5cm / 2.6in

SPECIFICATIONS / SPÉCIFICITÉS  
Flat pack / Livraison à plat  
Max table top weight / Poids max plateau : 70kg / 154.31bs

**ECO IMPACT SCORE**



● ● 120x60cm / 47.2x23.6in

Wall mounted desk  
Bureau mural



MATERIALS / MATÉRIAUX

Steel / Acier  
Aluminium

Tabletop options :

Oak veneered plywood «Oak» / Contreplaqué plaqué chêne «Chêne»  
Solid oak «Old oak» / Chêne massif «Bois ancien»

MANUFACTURING / ORIGINES

Made in Europe

Metal parts : Lithuania, France, Bulgaria

Wood : Croatia, Bosnia

DIMENSIONS

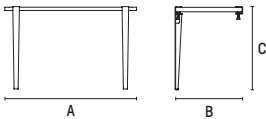

(A) Length / Longueur : 120cm / 47.2in

(B) Width / Largeur : 60cm / 23.6in

(C) Height / Hauteur : 75cm / 29.5in

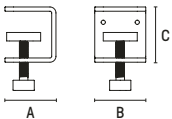

(A) Length / Longueur : 6cm / 2.4in

(B) Width / Largeur : 6cm / 2.4in

(C) Height / Hauteur : 6,5cm / 2.6in

SPECIFICATIONS / SPÉCIFICITÉS

Flat pack / Livraison à plat

Max table top weight / Poids max plateau : 70kg / 154.31bs

ECO IMPACT SCORE



● 120x60cm / 47.2x23.6in

Drawer unit  
Bloc de rangement



MATERIALS / MATÉRIAUX

Steel / Acier

MANUFACTURING / ORIGINES

France

COLORS / COULEURS

Graphite black / Noir graphite

Cream white / Blanc crème

Eucalyptus grey / Gris eucalyptus



DIMENSIONS

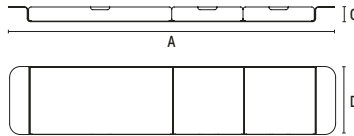

(A) Length / Longueur : 110cm / 43.3in

(C) Height / Hauteur : 7cm / 2.8in

(D) Depth / Profondeur : 25cm / 9.8in

SPECIFICATIONS / SPÉCIFICITÉS

Flat pack / Livraison à plat

ECO IMPACT SCORE

Not rated yet / Non évalué à date

**TIPTOE COLLECTION**  
by Tiptoe studio

North America use rating

RESIDENTIAL

| TABLE LEG<br>PIED DE TABLE         | HEIGHT<br>HAUTEUR |   |
|------------------------------------|-------------------|---|
|                                    | 90cm / 35.4in     |   |
| Graphite black<br>Noir graphite    | ●                 | ● |
| Cream white<br>Blanc crème         | ○                 | ● |
| Eucalyptus grey<br>Gris eucalyptus | ●                 | ● |
| Khaki green<br>Vert kaki           | ●                 | ● |

| TABLE TOP<br>PLATEAU   | SIZE<br>TAILLE                                   |   |
|------------------------|--|---|
|                        | 120x60cm / 47.2x23.6in<br>150x75cm / 59.1x29.5in |   |
| Oak<br>Chêne           | ●  | ● |
| Old oak<br>Bois ancien | ●  | ● |

TABLE TOP THICKNESS / ÉPAISSEUR PLATEAU

Oak / Chêne : 4cm / 1.6in

Old oak / Bois ancien : 4cm / 1.6in

**Tiptoe table leg - 90cm / 34.5in**  
& wall Bracket  
Pied de table Tiptoe - 90cm  
& accroche murale Bracket



MATERIALS / MATÉRIAUX

Steel / Acier  
Aluminium

MANUFACTURING / ORIGINES

Made in Europe  
Metal parts : Lithuania, France

DIMENSIONS

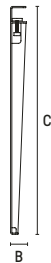

(B) Width / Largeur : 6cm / 2.4in  
(C) Height / Hauteur : 90cm / 34.5in

WEIGHT / POIDS

3,5kg / 7.7lbs

SPECIFICATIONS / SPÉCIFICITÉS

Flat pack / Livraison à plat

ECO IMPACT SCORE



**Wall-mounted dining table**  
Table à manger murale



MATERIALS / MATÉRIAUX

Steel / Acier  
Aluminium

Tabletop options :

Oak veneered plywood «Oak» / Contreplaqué plaqué chêne «Chêne»  
Solid oak «Old oak» / Chêne massif «Bois ancien»

MANUFACTURING / ORIGINES

Made in Europe  
Metal parts : Lithuania, France, Bulgaria  
Wood : Croatia, Bosnia

DIMENSIONS

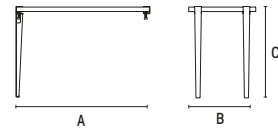

(A) Length / Longueur : 120cm / 47.2in  
(B) Width / Largeur : 60cm / 23.6in  
(C) Height / Hauteur : 75cm / 29.5in

(A) Length / Longueur : 150cm / 59.1in  
(B) Width / Largeur : 75cm / 29.5in  
(C) Height / Hauteur : 75cm / 29.5in

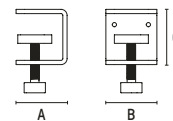

(A) Length / Longueur : 6cm / 2.4in  
(B) Width / Largeur : 6cm / 2.4in  
(C) Height / Hauteur : 6,5cm / 2.6in

SPECIFICATIONS / SPÉCIFICITÉS

Flat pack / Livraison à plat

Max table top weight / Poids max plateau : 70kg / 154.3lbs

ECO IMPACT SCORE



● ● ● 120x60cm / 47.2x23.6in

Tiptoe table leg - 110cm / 43.3in  
& wall Bracket  
Pied de table Tiptoe - 110cm  
& accroche murale Bracket

Wall-mounted dining table  
Table à manger murale

North America use rating

RESIDENTIAL

| TABLE LEG<br>PIED DE TABLE         | HEIGHT<br>HAUTEUR |
|------------------------------------|-------------------|
|                                    | 110cm / 43.3in    |
| Graphite black<br>Noir graphite    | ● ●               |
| Cream white<br>Blanc crème         | ○ ●               |
| Eucalyptus grey<br>Gris eucalyptus | ● ●               |
| Khaki green<br>Vert kaki           | ● ●               |

| TABLE TOP<br>PLATEAU   | SIZE<br>TAILLE                                   |
|------------------------|--|
|                        | 120x60cm / 47.2x23.6in<br>150x75cm / 59.1x29.5in |
| Oak<br>Chêne           | ● ●  |
| Old oak<br>Bois ancien | ● ●  |

TABLE TOP THICKNESS / ÉPAISSEUR PLATEAU

Oak / Chêne : 4cm / 1.6in  
Old oak / Bois ancien : 4cm / 1.6in



MATERIALS / MATÉRIAUX  
Steel / Acier  
Aluminium

MANUFACTURING / ORIGINES  
Made in Europe  
Metal parts : Lithuania, France



MATERIALS / MATÉRIAUX  
Steel / Acier  
Aluminium

Tabletop options :  
Oak veneered plywood «Oak» / Contreplaqué plaqué chêne «Chêne»  
Solid oak «Old oak» / Chêne massif «Bois ancien»

MANUFACTURING / ORIGINES  
Made in Europe  
Metal parts : Lithuania, France, Bulgaria  
Wood : Croatia, Bosnia

DIMENSIONS



(B) Width / Largeur : 6cm / 2.4in  
(C) Height / Hauteur : 110cm / 43.3in

WEIGHT / POIDS  
4,5kg / 9.9lbs

SPECIFICATIONS / SPÉCIFICITÉS  
Flat pack / Livraison à plat

ECO IMPACT SCORE



DIMENSIONS

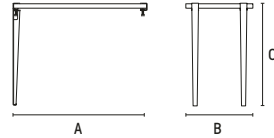

(A) Length / Longueur : 120cm / 47.2in  
(B) Width / Largeur : 60cm / 23.6in  
(C) Height / Hauteur : 75cm / 29.5in

(A) Length / Longueur : 150cm / 59.1in  
(B) Width / Largeur : 75cm / 29.5in  
(C) Height / Hauteur : 75cm / 29.5in

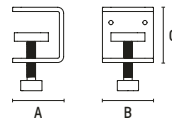

(A) Length / Longueur : 6cm / 2.4in  
(B) Width / Largeur : 6cm / 2.4in  
(C) Height / Hauteur : 6,5cm / 2.6in

SPECIFICATIONS / SPÉCIFICITÉS  
Flat pack / Livraison à plat

Max table top weight / Poids max plateau : 70kg / 154.3lbs

ECO IMPACT SCORE



● ● 120x60cm / 47.2x23.6in

**TIPTOE COLLECTION**  
by Tiptoe studio

North America use rating

RESIDENTIAL

| TABLE LEG<br>PIED DE TABLE         | HEIGHT<br>HAUTEUR |
|------------------------------------|-------------------|
| Graphite black<br>Noir graphite    | 43cm / 16.9in     |
| Cream white<br>Blanc crème         |                   |
| Eucalyptus grey<br>Gris eucalyptus |                   |
| Khaki green<br>Vert kaki           |                   |
| Midnight blue<br>Bleu nuit         |                   |
| Azure blue<br>Bleu azur            |                   |
| Pale blue<br>Bleu pâle             |                   |
| Brioche yellow<br>Jaune brioche    |                   |
| Tangerine red<br>Rouge tangerine   |                   |

| TABLE TOP<br>PLATEAU                      | SIZE<br>TAILLE | 120x30cm / 47.2x11.8in | 120x60cm / 47.2x23.6in | 100x50cm / 39.4x19.7in | ø80-ø90cm / ø31.5-ø35.4in | 120x75cm / 47.2x29.5in | 120x48cm / 47.2x18.9in | 80x80cm / 31.5x31.5in |
|---|----------------|------------------------|------------------------|------------------------|---------------------------|------------------------|------------------------|-----------------------|
| Oak<br>Chêne                              |                | •                      | •                      | •                      | •                         | •                      | •                      | •                     |
| Old oak<br>Bois ancien                    |                | •                      | •                      | •                      | •                         |                        |                        |                       |
| Venezia rec. plas.<br>Plas. rec. Venezia  |                | •                      | •                      | •                      | •                         |                        |                        |                       |
| Versailles flooring<br>Parquet Versailles |                |                        |                        |                        |                           |                        |                        | •                     |

TABLE TOP THICKNESS / ÉPAISSEUR PLATEAU

Oak / Chêne : 3cm / 1.2in  
Old oak / Bois ancien : 3cm / 1.2in  
Venezia rec. plas. / Plas. rec. Venezia : 2cm / 0.8in  
Versailles flooring / Parquet Versailles : 4cm / 1.6in

**Tiptoe table leg - 43cm / 16.9in\***  
Pied de table Tiptoe - 43cm



**MATERIALS / MATÉRIAUX**  
Steel / Acier  
Aluminium

**MANUFACTURING / ORIGINES**  
Made in Europe  
Metal parts : Lithuania, France

**DIMENSIONS**

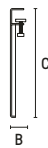

(B) Width / Largeur : 6cm / 2.4in  
(C) Height / Hauteur : 43cm / 16.9in

**WEIGHT / POIDS**

1kg / 2.2lbs

**SPECIFICATIONS / SPÉCIFICITÉS**

Flat pack / Livraison à plat

**ECO IMPACT SCORE**



**Occasional bench\***  
Banc d'appoint



**MATERIALS / MATÉRIAUX**  
Steel / Acier  
Aluminium

Tabletop options :  
Solid oak «Oak» / Chêne massif «Chêne»  
Solid oak «Old oak» / Chêne massif «Bois ancien»

**MANUFACTURING / ORIGINES**

Made in Europe  
Metal parts : Lithuania, France  
Wood : Croatia, Bosnia

**DIMENSIONS**

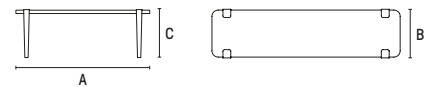

(A) Length / Longueur : 120cm / 47.2in  
(B) Width / Largeur : 30cm / 11.8in  
(C) Height / Hauteur : 43cm / 16.9in

**SPECIFICATIONS / SPÉCIFICITÉS**

Flat pack / Livraison à plat  
Max table top weight / Poids max plateau : 70kg / 154.3lbs

**ECO IMPACT SCORE**



Coffee table\*  
Table basse



MATERIALS / MATÉRIAUX

Steel / Acier

Aluminium

Tabletop options :

Solid oak «Oak» / Chêne massif «Chêne»

Solid oak «Old oak» / Chêne massif «Bois ancien»

HIPS (High Impact Polystyrene) «Venezia»

MANUFACTURING / ORIGINES

Made in Europe

Metal parts : Lithuania, France

Wood : Croatia, Bosnia

Recycled plastic : UK

DIMENSIONS

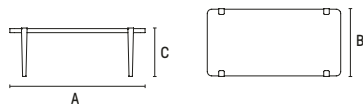

(A) Length / Longueur : 120cm / 47.2in  
(B) Width / Largeur : 60cm / 23.6in  
(C) Height / Hauteur : 43cm / 16.9in

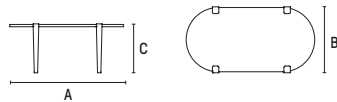

(A) Length / Longueur : 100cm / 39.4in  
(B) Width / Largeur : 50cm / 19.7in  
(C) Height / Hauteur : 43cm / 16.9in

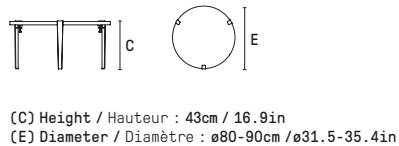

(C) Height / Hauteur : 43cm / 16.9in  
(E) Diameter / Diamètre : ø80-90cm / ø31.5-35.4in

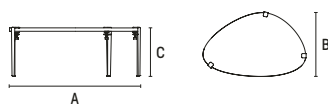

(A) Length / Longueur : 120cm / 47.2in  
(B) Width / Largeur : 75cm / 29.5in  
(C) Height / Hauteur : 43cm / 16.9in

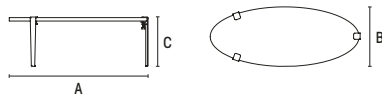

(A) Length / Longueur : 120cm / 47.2in  
(B) Width / Largeur : 48cm / 18.9in  
(C) Height / Hauteur : 43cm / 16.9in

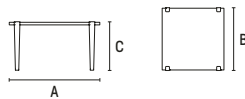

(A) Length / Longueur : 80cm / 31.5in  
(B) Width / Largeur : 80cm / 31.5in  
(C) Height / Hauteur : 43cm / 16.9in

SPECIFICATIONS / SPÉCIFICITÉS

Flat pack / Livraison à plat

Max table top weight / Poids max plateau : 70kg / 154.31bs

VENEZIA RECYCLED PLASTIC

HIPS (High Impact Polystyrene)

VERSAILLES FLOORING

Solid oak



ECO IMPACT SCORE



**PRODUCT GUIDELINES**  
RECOMMANDATIONS D'USAGE

**Tiptoe table leg - 75cm / 29.5in**  
Pied de table Tiptoe - 75cm

North America use rating  
**RESIDENTIAL**

 Do not overtighten the screw with the Allen key.  
Ne pas trop serrer la vis avec la clé Allen.

The 75cm / 29.5in table legs can be used for freestanding or wall-mounted tables and desks.  
Le pied 75cm peut être utilisé pour des tables et bureaux autoportants ou muraux.

**TABLETOP THICKNESS / ÉPAISSEUR DU PLATEAU**

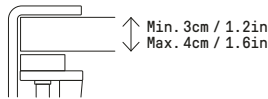

**TABLETOP GUIDELINES / RÈGLES D'INSTALLATION**

Freestanding table / Table autoportante

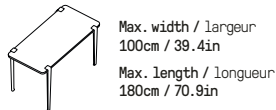

Wall-mounted table / Table murale

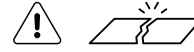
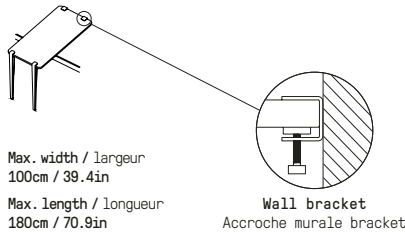

**MATERIAL RESTRICTIONS / RESTRICTIONS DES MATÉRIAUX**

Do not use brittle materials such as glass, marble or stone for the tabletop.

Ne pas utiliser de matériaux cassants pour le plateau, tels que le verre, le marbre ou la pierre.

**LARGE TABLES GUIDELINES / RÈGLES POUR LES GRANDES TABLES**

For tabletops longer than 180cm / 70.9in, the tabletop thickness must be 4cm / 1.6in, and two additional legs must be added every 100cm / 39.4in.

Pour les plateaux de plus de 180cm, l'épaisseur du plateau doit être de 4cm et deux pieds supplémentaires doivent être ajoutés tous les 100cm.

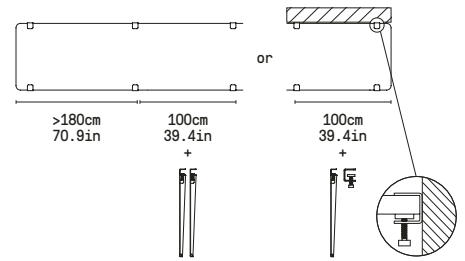

**Tiptoe table leg - 43cm / 16.9in\***  
Pied de table Tiptoe - 43cm

North America use rating  
\*Product not available for the US market  
**RESIDENTIAL**

 Do not overtighten the screw with the Allen key.  
Ne pas trop serrer la vis avec la clé Allen.

The 43cm / 16.9in table legs can only be used for freestanding tables.  
Le pied 43cm peut être uniquement utilisé pour des tables autoportantes.

**TABLETOP THICKNESS / ÉPAISSEUR DU PLATEAU**

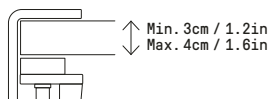

**TABLETOP GUIDELINES / RÈGLES D'INSTALLATION**

Freestanding table / Table autoportante

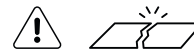
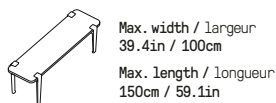
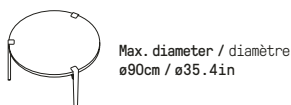
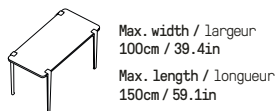

**MATERIAL RESTRICTIONS / RESTRICTIONS DES MATÉRIAUX**

Do not use brittle materials such as glass, marble or stone for the tabletop.

Ne pas utiliser de matériaux cassants pour le plateau, tels que le verre, le marbre ou la pierre.



**Tiptoe table leg - 90cm / 34.5in**  
**Pied de table Tiptoe - 90cm**

North America use rating  
**RESIDENTIAL**

 Do not overtighten the screw with the Allen key.  
 Ne pas trop serrer la vis avec la clé Allen.

The 90cm / 34.5in table leg is designed exclusively for wall-mounted tables and desks. It must be used with the Tiptoe wall bracket or an suitable wall mounting system.  
 Le pied Tiptoe 90cm est exclusivement conçu pour des tables et bureaux muraux. Il doit être utilisé avec le support mural Tiptoe ou un système de fixation murale adapté.



**TABLETOP THICKNESS / ÉPAISSEUR DU PLATEAU**

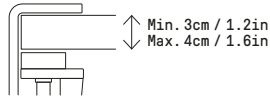

**TABLETOP GUIDELINES / RÈGLES D'INSTALLATION**

Wall-mounted table / Table murale

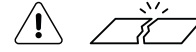
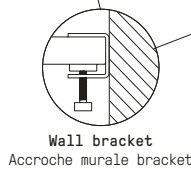
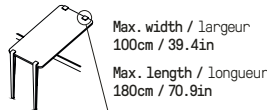

**MATERIAL RESTRICTIONS / RESTRICTIONS DES MATÉRIAUX**  
 Do not use brittle materials such as glass, marble or stone for the tabletop.  
 Ne pas utiliser de matériaux cassants pour le plateau, tels que le verre, le marbre ou la pierre.

**LARGE TABLES GUIDELINES / RÈGLES POUR LES GRANDES TABLES**

For tabletops longer than 180cm / 70.9in, the tabletop thickness must be 4cm / 1.6in, and two additional legs and/or wall brackets must be added every 100cm / 39.4in.  
 Pour les plateaux de plus de 180cm, l'épaisseur du plateau doit être de 4cm et deux pieds supplémentaires et/ou supports muraux doivent être ajoutés tous les 100cm.

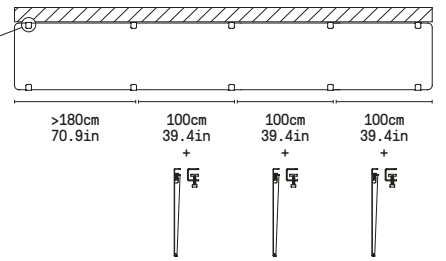

**Tiptoe table leg - 110cm / 43.3in**  
**Pied de table Tiptoe - 110cm**

North America use rating  
**RESIDENTIAL**

 Do not overtighten the screw with the Allen key.  
 Ne pas trop serrer la vis avec la clé Allen.

The 110cm / 43.3in table leg is designed exclusively for wall-mounted tables and desks. It must be used with the Tiptoe wall bracket or an suitable wall mounting system.  
 Le pied Tiptoe 110cm est exclusivement conçu pour des tables et bureaux muraux. Il doit être utilisé avec le support mural Tiptoe ou un système de fixation murale adapté.



**TABLETOP THICKNESS / ÉPAISSEUR DU PLATEAU**

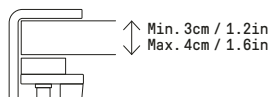

**TABLETOP GUIDELINES / RÈGLES D'INSTALLATION**

Wall-mounted table / Table murale

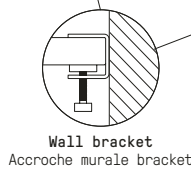
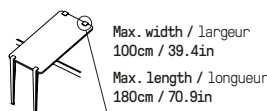

**MATERIAL RESTRICTIONS / RESTRICTIONS DES MATÉRIAUX**  
 Do not use brittle materials such as glass, marble or stone for the tabletop.  
 Ne pas utiliser de matériaux cassants pour le plateau, tels que le verre, le marbre ou la pierre.

**LARGE TABLES GUIDELINES / RÈGLES POUR LES GRANDES TABLES**

For tabletops longer than 180cm / 70.9in, the tabletop thickness must be 4cm / 1.6in, and two additional legs and/or wall brackets must be added every 100cm / 39.4in.  
 Pour les plateaux de plus de 180cm, l'épaisseur du plateau doit être de 4cm et deux pieds supplémentaires et/ou supports muraux doivent être ajoutés tous les 100cm.

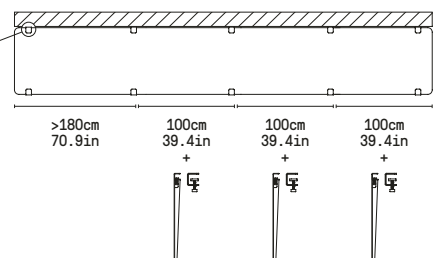

NEW MODERN LIVING COLLECTION  
by Tiptoe studio

Dining table  
Table à manger

North America use rating

|             |   |
|-------------|---|
| RESIDENTIAL | ● |
| CONTRACT    | ● |

| TABLE LEG<br>PIED DE TABLE         | HEIGHT<br>HAUTEUR |
|------------------------------------|-------------------|
| Graphite black<br>Noir graphite    | ● ●               |
| Cream white<br>Blanc crème         | ○ ●               |
| Eucalyptus grey<br>Gris eucalyptus | ● ●               |
| Khaki green<br>Vert kaki           | ● ●               |
| Pale blue<br>Bleu pâle             | ● ●               |

| TABLE TOP<br>PLATEAU                     | SIZE<br>TAILLE | 160x95cm / 63x37.4in | 190x95cm / 74.8x37.4in | 220x95cm / 86.6x37.4in | 240x95cm / 94.5x37.4in | ø110cm / ø43.3in | 130x70cm / 51.2x27.6in | 150x70cm / 59.1x27.6in |
|--|----------------|----------------------|------------------------|------------------------|------------------------|------------------|------------------------|------------------------|
| Oak<br>Chêne                             | ●              | ●                    | ●                      | ●                      | ●                      | ●                | ●                      | ●                      |
| Old oak<br>Bois ancien                   | ●              | ●                    | ●                      | ●                      | ●                      | ●                | ●                      | ●                      |
| Venezia rec. plas.<br>Plas. rec. Venezia | ○              | ●                    | ●                      | ●                      | ●                      | ●                | ●                      | ●                      |

TABLE TOP THICKNESS / ÉPAISSEUR PLATEAU

Oak / Chêne : 2,5cm / 1in  
Old oak / Bois ancien : 2,5cm / 1in  
Venezia rec. plas. / Plas. rec. Venezia : 2cm / 0.8in

VENEZIA RECYCLED PLASTIC

HIPS (High Impact Polystyrene)



MATERIALS / MATÉRIAUX

Steel / Acier  
Stainless steel / Acier inoxydable

Tabletop options :

Oak veneered plywood «Oak» / Contreplaqué plaqué chêne «Chêne»  
Solid oak «Old oak» / Chêne massif «Bois ancien»  
HIPS (High Impact Polystyrene) «Venezia»

MANUFACTURING / ORIGINES

Made in Europe  
Metal parts : Lithuania, France  
Wood : Croatia, Bosnia  
Recycled plastic : UK

DIMENSIONS

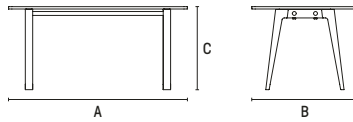

(A) Length / Longueur : 160cm / 63in  
(B) Width / Largeur : 95cm / 37.4in  
(C) Height / Hauteur : 75cm / 29.5in

(A) Length / Longueur : 190cm / 74.8in  
(B) Width / Largeur : 95cm / 37.4in  
(C) Height / Hauteur : 75cm / 29.5in

(A) Length / Longueur : 220cm / 86.6in  
(B) Width / Largeur : 95cm / 37.4in  
(C) Height / Hauteur : 75cm / 29.5in

(A) Length / Longueur : 240cm / 94.5in  
(B) Width / Largeur : 95cm / 37.4in  
(C) Height / Hauteur : 75cm / 29.5in

SPECIFICATIONS / SPÉCIFICITÉS

Flat pack / Livraison à plat  
Adjustable foot / Vérins réglables : 1cm / 0.4in

ECO IMPACT SCORE



MATERIALS / MATÉRIAUX

Steel / Acier  
Stainless steel / Acier inoxydable

Tabletop options :

Oak veneered plywood «Oak» / Contreplaqué plaqué chêne «Chêne»  
Solid oak «Old oak» / Chêne massif «Bois ancien»  
HIPS (High Impact Polystyrene) «Venezia»

MANUFACTURING / ORIGINES

Made in Europe  
Metal parts : Lithuania, France  
Wood : Croatia, Bosnia  
Recycled plastic : UK

DIMENSIONS

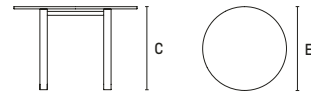

(C) Height / Hauteur : 75cm / 29.5in  
(E) Diameter / Diamètre : ø110cm / ø43.3in

SPECIFICATIONS / SPÉCIFICITÉS

Flat pack / Livraison à plat  
Adjustable foot / Vérins réglables : 1cm / 0.4in

ECO IMPACT SCORE



**Desk and drawer unit**  
Bureau et bloc de rangement



**MATERIALS / MATÉRIAUX**  
Steel / Acier  
Stainless steel / Acier inoxydable  
Tabletop options :  
Oak veneered plywood «Oak» / Contreplaqué plaqué chêne «Chêne»  
Solid oak «Old oak» / Chêne massif «Bois ancien»  
HIPS (High Impact Polystyrene) «Venezia»

**MANUFACTURING / ORIGINES**  
Made in Europe  
Metal parts : Lithuania, France  
Wood : Bosnia  
Recycled plastic : UK

**DIMENSIONS**

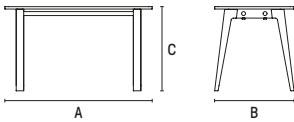

(A) Length / Longueur : 130cm / 51.2in  
(B) Width / Largeur : 70cm / 27.6in  
(C) Height / Hauteur : 75cm / 29.5in

(A) Length / Longueur : 150cm / 59.1in  
(B) Width / Largeur : 70cm / 27.6in  
(C) Height / Hauteur : 75cm / 29.5in

**SPECIFICATIONS / SPÉCIFICITÉS**

Flat pack / Livraison à plat  
Adjustable foot / Vérins réglables : 1cm / 0.4in

**ECO IMPACT SCORE**



**MATERIALS / MATÉRIAUX**  
Steel / Acier

**MANUFACTURING / ORIGINES**  
France

**COLORS / COULEURS**  
Graphite black / Noir graphite  
Cream white / Blanc crème  
Eucalyptus grey / Gris eucalyptus

**DIMENSIONS**

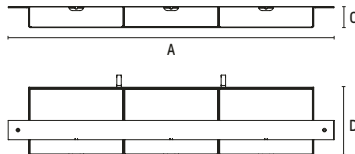

(A) Length / Longueur : 96cm / 37.8in  
(C) Height / Hauteur : 7cm / 2.8in  
(D) Depth / Profondeur : 22cm / 8.7in

**SPECIFICATIONS / SPÉCIFICITÉS**

Flat pack / Livraison à plat

**ECO IMPACT SCORE**

Not rated yet / Non évalué à date

NEW MODERN WORKING COLLECTION  
by Tiptoe studio

Bar table  
Table haute

North America use rating

|             |   |
|-------------|---|
| RESIDENTIAL | • |
| CONTRACT    | • |

| TABLE LEG<br>PIED DE TABLE         | HEIGHT<br>HAUTEUR | 90cm / 35.4in | 105cm / 41.3in |
|------------------------------------|-------------------|---------------|----------------|
| Graphite black<br>Noir graphite    | ●                 | •             | •              |
| Cream white<br>Blanc crème         | ○                 | •             | •              |
| Eucalyptus grey<br>Gris eucalyptus | ●                 | •             | •              |

| TABLE TOP<br>PLATEAU                     | SIZE<br>TAILLE | 130x70cm / 51.2x27.6in | 150x70cm / 59.1x27.6in | 160x95cm / 63x37.4in | 190x95cm / 74.8x37.4in | 220x95cm / 86.6x37.4in | ø110cm / ø43.3in |
|--|----------------|------------------------|------------------------|----------------------|------------------------|------------------------|------------------|
| Oak<br>Chêne                             | ●              | •                      | •                      | •                    | •                      | •                      | •                |
| Old oak<br>Bois ancien                   | ●              |                        | •                      | •                    | •                      | •                      | •                |
| Venezia rec. plas.<br>Plas. rec. Venezia | ○              | •                      | •                      | •                    | •                      | •                      | •                |

TABLE TOP THICKNESS / ÉPAISSEUR PLATEAU

Oak / Chêne : 2,5cm / 1in

Old oak / Bois ancien : 2,5cm / 1in

Venezia rec. plas. / Plas. rec. Venezia : 2cm / 0.8in

VENEZIA RECYCLED PLASTIC

HIPS (High Impact Polystyrene)



MATERIALS / MATÉRIAUX

Steel / Acier

Stainless steel / Acier inoxydable

Tabletop options :

Oak veneered plywood «Oak» / Contreplaqué plaqué chêne «Chêne»

Solid oak «Old oak» / Chêne massif «Bois ancien»

HIPS (High Impact Polystyrene) «Venezia»

MANUFACTURING / ORIGINES

Made in Europe

Metal parts : Lithuania, France, Bulgaria

Wood : Croatia, Bosnia

Recycled plastic : UK

DIMENSIONS

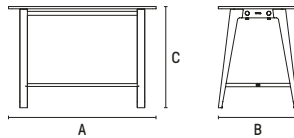

(A) Length / Longueur : 130cm / 51.2in

(B) Width / Largeur : 70cm / 27.6in

(C) Height / Hauteur : 90cm / 35.4in or 105cm / 41.3in

(A) Length / Longueur : 150cm / 59.1in

(B) Width / Largeur : 70cm / 27.6in

(C) Height / Hauteur : 90cm / 35.4in or 105cm / 41.3in

(A) Length / Longueur : 160cm / 63in

(B) Width / Largeur : 95cm / 37.4in

(C) Height / Hauteur : 90cm / 35.4in or 105cm / 41.3in

(A) Length / Longueur : 190cm / 74.8in

(B) Width / Largeur : 95cm / 37.4in

(C) Height / Hauteur : 90cm / 35.4in or 105cm / 41.3in

(A) Length / Longueur : 220cm / 86.6in

(B) Width / Largeur : 95cm / 37.4in

(C) Height / Hauteur : 90cm / 35.4in or 105cm / 41.3in

SPECIFICATIONS / SPÉCIFICITÉS

Flat pack / Livraison à plat

Adjustable foot / Vérins réglables : 1cm / 0.4in

ECO IMPACT SCORE



MATERIALS / MATÉRIAUX

Steel / Acier

Stainless steel / Acier inoxydable

Tabletop options :

Oak veneered plywood «Oak» / Contreplaqué plaqué chêne «Chêne»

Solid oak «Old oak» / Chêne massif «Bois ancien»

HIPS (High Impact Polystyrene) «Venezia»

MANUFACTURING / ORIGINES

Made in Europe

Metal parts : Lithuania, France, Bulgaria

Wood : Croatia, Bosnia

Recycled plastic : UK

DIMENSIONS

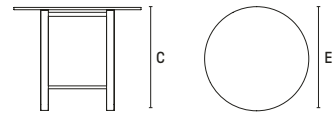

(C) Height / Hauteur : 90cm / 35.4in or 105cm / 41.3in

(E) Diameter / Diamètre : ø110cm / ø43.3in

SPECIFICATIONS / SPÉCIFICITÉS

Flat pack / Livraison à plat

Adjustable foot / Vérins réglables : 1cm / 0.4in

ECO IMPACT SCORE



## Workstation Bureau open-space

## Meeting table Table de réunion

| Workstation<br>Bureau open-space | HEIGHT<br>HAUTEUR | 75cm / 29.5in | Meeting table<br>Table de réunion  | HEIGHT<br>HAUTEUR | 75cm / 29.5in |
|----------------------------------|-------------------|---------------|------------------------------------|-------------------|---------------|
| TABLE LEG<br>PIED DE TABLE       |                   |               | TABLE LEG<br>PIED DE TABLE         |                   |               |
| Graphite black<br>Noir graphite  | ●                 | ●             | Graphite black<br>Noir graphite    | ●                 | ●             |
| Cream white<br>Blanc crème       | ○                 | ●             | Cream white<br>Blanc crème         | ○                 | ●             |
|                                  |                   |               | Eucalyptus grey<br>Gris eucalyptus | ●                 | ●             |
|                                  |                   |               | Khaki green<br>Vert kaki           | ●                 | ●             |
|                                  |                   |               | Pale blue<br>Bleu pâle             | ●                 | ●             |

| TABLE TOP<br>PLATEAU                     | SIZE<br>TAILLE | 130x140cm / 51.2x55.1in | 150x140cm / 59.1x55.1in | 240x140cm / 94.5x55.1in | 280x140cm / 110x55.1in | 160x95cm / 63x37.4in | 190x95cm / 74.8x37.4in | 220x95cm / 86.6x37.4in | 240x95cm / 94.5x37.4in |
|--|----------------|-------------------------|-------------------------|-------------------------|------------------------|----------------------|------------------------|------------------------|------------------------|
| Oak<br>Chêne                             | ●              |                         |                         |                         |                        | ●                    | ●                      | ●                      | ●                      |
| Old oak<br>Bois ancien                   | ●              |                         |                         |                         |                        | ●                    | ●                      | ●                      | ●                      |
| Venezia rec. plas.<br>Plas. rec. Venezia | ○              | ●                       | ●                       |                         |                        | ●                    | ●                      | ●                      | ●                      |
| White plywood<br>Stratifié blanc         | ●              | ●                       | ●                       | ●                       | ●                      | ●                    | ●                      | ●                      | ●                      |

### TABLE TOP THICKNESS / ÉPAISSEUR PLATEAU

Oak / Chêne : 2,5cm / 1in  
 Old oak / Bois ancien : 2,5cm / 1in  
 Venezia rec. plas. / Plas. rec. Venezia : 2cm / 0.8in  
 White plywood / Stratifié blanc : 4cm / 1.6in

## Options

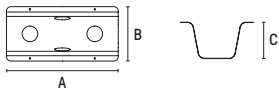

### Cable hole / Goulotte

(A) Length / Longueur : 50cm / 19.7in  
 (B) Width / Largeur : 25cm / 9.8in  
 (C) Height / Hauteur : 12cm / 4.7in

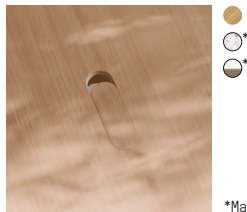

\*Made to order

### Cut-out / Découpe centrale

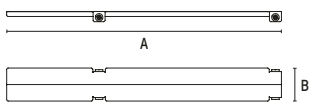

### Cable holder / Passe câble

(A) Length / Longueur : 55cm / 21.7in  
 (B) Width / Largeur : 7cm / 2.8in



### MATERIALS / MATÉRIAUX

Steel / Acier  
 Stainless steel / Acier inoxydable

### Tabletop options :

White laminated plywood / Contreplaqué stratifié blanc  
 Oak veneered plywood «Oak» / Contreplaqué plaqué chêne «Chêne»  
 HIPS (High Impact Polystyrene) «Venezia»

### MANUFACTURING / ORIGINES

Made in Europe  
 Metal parts : Lithuania, France  
 Wood : Croatia, Bosnia  
 Recycled plastic : UK

### DIMENSIONS

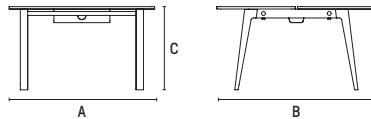

### 2 seats / 2 places

(A) Length / Longueur : 130cm / 51.2in  
 (B) Width / Largeur : 140cm / 55.1in  
 (C) Height / Hauteur : 75cm / 29.5in

### 2 seats / 2 places

(A) Length / Longueur : 150cm / 59.1in  
 (B) Width / Largeur : 140cm / 55.1in  
 (C) Height / Hauteur : 75cm / 29.5in

### 4 seats / 4 places

(A) Length / Longueur : 240cm / 94.5in  
 (B) Width / Largeur : 140cm / 55.1in  
 (C) Height / Hauteur : 75cm / 29.5in

### 4 seats / 4 places

(A) Length / Longueur : 280cm / 110.2in  
 (B) Width / Largeur : 140cm / 55.1in  
 (C) Height / Hauteur : 75cm / 29.5in

### SPECIFICATIONS / SPÉCIFICITÉS

Flat pack / Livraison à plat  
 Adjustable foot / Vérins réglables : 1cm / 0.4in

### ECO IMPACT SCORE



### MATERIALS / MATÉRIAUX

Steel / Acier  
 Stainless steel / Acier inoxydable

### Tabletop options :

Oak veneered plywood «Oak» / Contreplaqué plaqué chêne «Chêne»  
 Solid oak «Old oak» / Chêne massif «Bois ancien»  
 HIPS (High Impact Polystyrene) «Venezia»

### MANUFACTURING / ORIGINES

Made in Europe  
 Metal parts : Lithuania, France  
 Wood : Croatia, Bosnia  
 Recycled plastic : UK

### DIMENSIONS

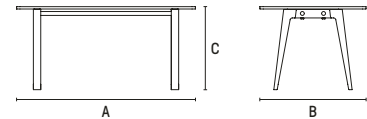

(A) Length / Longueur : 160cm / 63in  
 (B) Width / Largeur : 95cm / 37.4in  
 (C) Height / Hauteur : 75cm / 29.5in

(A) Length / Longueur : 190cm / 74.8in  
 (B) Width / Largeur : 95cm / 37.4in  
 (C) Height / Hauteur : 75cm / 29.5in

(A) Length / Longueur : 220cm / 86.6in  
 (B) Width / Largeur : 95cm / 37.4in  
 (C) Height / Hauteur : 75cm / 29.5in

(A) Length / Longueur : 240cm / 94.5in  
 (B) Width / Largeur : 95cm / 37.4in  
 (C) Height / Hauteur : 75cm / 29.5in

### SPECIFICATIONS / SPÉCIFICITÉS

Flat pack / Livraison à plat  
 Adjustable foot / Vérins réglables : 1cm / 0.4in

### ECO IMPACT SCORE



**MOKA COLLECTION**  
by Tiptoe studio

**Coffee table\***  
Table basse

North America use rating

|             |   |
|-------------|---|
| RESIDENTIAL | • |
| CONTRACT    | • |

| TABLE LEG<br>PIED DE TABLE         | HEIGHT<br>HAUTEUR | 50cm / 19.7in | 75cm / 29.5in | 105cm / 41.3in |
|------------------------------------|-------------------|---------------|---------------|----------------|
| Graphite black<br>Noir graphite    | ●                 | •             | •             | •              |
| Cream white<br>Blanc crème         | ○                 | •             | •             | •              |
| Eucalyptus grey<br>Gris eucalyptus | ●                 | •             | •             | •              |

| TABLE TOP<br>PLATEAU                     | SIZE<br>TAILLE | Coffee table<br>ø48cm / ø18.9in | Coffee table<br>ø70cm / ø27.6in | Coffee table<br>70x70cm / 27.6x27.6in | Bistro table<br>ø70cm / ø27.6in | Bistro table<br>70x70cm / 27.6x27.6in | High table<br>ø70cm / ø27.6in |
|--|----------------|---------------------------------|---------------------------------|---------------------------------------|---------------------------------|---------------------------------------|-------------------------------|
| Oak<br>Chêne                             | ●              | •                               | •                               | •                                     | •                               | •                                     | •                             |
| Venezia rec. plas.<br>Plas. rec. Venezia | ○              |                                 |                                 |                                       | •                               | •                                     |                               |

TABLE TOP THICKNESS / ÉPAISSEUR PLATEAU

Oak / Chêne : 2,5cm / 1in

Venezia rec. plas. / Plas. rec. Venezia : 2cm / 0.8in

VENEZIA RECYCLED PLASTIC

HIIPS (High Impact Polystyrene)



**MATERIALS / MATÉRIAUX**  
Solid oak «Oak» / Chêne massif «Chêne»  
Steel / Acier

**MANUFACTURING / ORIGINES**

Made in Europe  
Metal parts : Lithuania  
Wood : Croatia



**MATERIALS / MATÉRIAUX**  
Solid oak «Oak» / Chêne massif «Chêne»  
Steel / Acier

**MANUFACTURING / ORIGINES**

Made in Europe  
Metal parts : Lithuania  
Wood : Croatia

**DIMENSIONS**

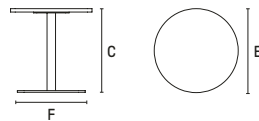

(C) Height / Hauteur : 50cm / 19.7in  
(E) Diameter / Diamètre : ø48cm / ø18.9in  
(F) Base / Socle : ø40cm / ø15.7in

(C) Height / Hauteur : 50cm / 19.7in  
(E) Diameter / Diamètre : ø70cm / ø27.6in  
(F) Base / Socle : ø40cm / ø15.7in

**DIMENSIONS**

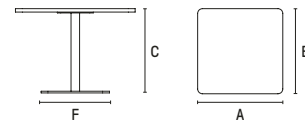

(A) Length / Longueur : 70cm / 27.6in  
(B) Width / Largeur : 70cm / 27.6in  
(C) Height / Hauteur : 50cm / 19.7in  
(F) Base / Socle : ø40cm / ø15.7in

**SPECIFICATIONS / SPÉCIFICITÉS**

Not flat pack / Non livré à plat

Adjustable foot / Vérins réglables : 1cm / 0.4in

**SPECIFICATIONS / SPÉCIFICITÉS**

Not flat pack / Non livré à plat

Adjustable foot / Vérins réglables : 1cm / 0.4in

**ECO IMPACT SCORE**



**ECO IMPACT SCORE**



**Bistro table**  
Table bistro



**MATERIALS / MATÉRIAUX**  
Steel / Acier  
Tabletop options :  
Solid oak «Oak» / Chêne massif «Chêne»  
HIPS (High Impact Polystyrene) «Venezia»

**MANUFACTURING / ORIGINES**  
Made in Europe  
Metal parts : Lithuania  
Wood : Croatia  
Recycled plastic : UK

**DIMENSIONS**

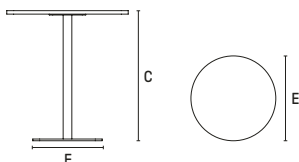

(C) Height / Hauteur : 75cm / 29.5in  
(E) Diameter / Diamètre : ø70cm / ø27.6in  
(F) Base / Socle : ø40cm / ø15.7in

**SPECIFICATIONS / SPÉCIFICITÉS**  
Not flat pack / Non livré à plat  
Adjustable foot / Vérins réglables : 1cm / 0.4in

**ECO IMPACT SCORE**



**Bar table\***  
Table haute



**MATERIALS / MATÉRIAUX**  
Steel / Acier  
Tabletop options :  
Solid oak «Oak» / Chêne massif «Chêne»  
HIPS (High Impact Polystyrene) «Venezia»

**MANUFACTURING / ORIGINES**  
Made in Europe  
Metal parts : Lithuania  
Wood : Croatia  
Recycled plastic : UK

**DIMENSIONS**

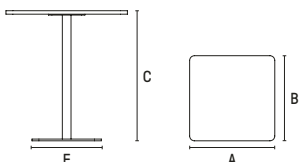

(A) Length / Longueur : 70cm / 27.6in  
(B) Width / Largeur : 70cm / 27.6in  
(C) Height / Hauteur : 75cm / 29.5in  
(F) Base / Socle : 40x40cm / 15.7x15.7in

**SPECIFICATIONS / SPÉCIFICITÉS**  
Not flat pack / Non livré à plat  
Adjustable foot / Vérins réglables : 1cm / 0.4in

**ECO IMPACT SCORE**



**MATERIALS / MATÉRIAUX**  
Solid oak «Oak» / Chêne massif «Chêne»  
Steel / Acier

**MANUFACTURING / ORIGINES**  
Made in Europe  
Metal parts : Lithuania  
Wood : Croatia

**DIMENSIONS**

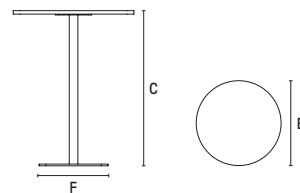

(C) Height / Hauteur : 105cm / 41.3in  
(E) Diameter / Diamètre : ø70cm / ø27.6in  
(F) Base / Socle : ø49cm / ø19.3in

**SPECIFICATIONS / SPÉCIFICITÉS**  
Not flat pack / Non livré à plat  
Adjustable foot / Vérins réglables : 1cm / 0.4in

**ECO IMPACT SCORE**



## SSD COLLECTION

BESPOKE OPTIONS AVAILABLE  
SUR-MESURE DISPONIBLE 



SSD chair



SSDr chair



SSD bar chair



SSDr bar chair



SSD soft chair



SSD steel bar stool

## SSD FULL WOOD COLLECTION

BESPOKE OPTIONS AVAILABLE  
SUR-MESURE DISPONIBLE 



SSD Full Wood chair



SSD Full Wood stool



SSD Full Wood bar stool

## LOU COLLECTION

BESPOKE OPTIONS AVAILABLE  
SUR-MESURE DISPONIBLE 



Lou stool



Lou stool - Chroma Edition



Lou bar stool



Lou bench

## ÉTUDE COLLECTION



Etude chair



Etude fabric chair



Monochrome Etude armchair



Etude lounge chair



Etude lounge armchair



Etude fabric lounge armchair

**CHAIR, STOOL & BENCH**  
**CHAISE, TABOURET & BANC**



**SSD COLLECTION**  
by Tiptoe studio

North America use rating

|             |   |
|-------------|---|
| RESIDENTIAL | • |
| CONTRACT    | • |

| Chair<br>Chaise                    | SEAT & BACK<br>ASSISE & DOSSIER | Oak / Chêne | Walnut / Noyer | Recycled plastic |
|------------------------------------|---------------------------------|-------------|----------------|------------------|
| FRAME<br>STRUCTURE                 |                                 | ●           | ●              | ●                |
| Graphite black<br>Noir graphite    | ●                               | •           | •              | •                |
| Cream white<br>Blanc crème         | ○                               | •           | •              | •                |
| Eucalyptus grey<br>Gris eucalyptus | ●                               | •           | •              | •                |
| Khaki green<br>Vert kaki           | ●                               | •           | •              | •                |
| Pale blue<br>Bleu pâle             | ●                               | •           | •              | •                |

| Bar chair<br>Chaise de bar         | SEAT & BACK<br>ASSISE & DOSSIER | Oak / Chêne | Recycled plastic |
|------------------------------------|---------------------------------|-------------|------------------|
| FRAME<br>STRUCTURE                 |                                 | ●           | ●                |
| Graphite black<br>Noir graphite    | ●                               | •           | •                |
| Cream white<br>Blanc crème         | ○                               | •           | •                |
| Eucalyptus grey<br>Gris eucalyptus | ●                               | •           | •                |
| Khaki green<br>Vert kaki           | ●                               | •           | •                |

**SSD chair**  
Chaise SSD



**MATERIALS / MATÉRIAUX**  
Oak veneered plywood «Oak» / Contreplaqué plaqué chêne «Chêne»  
Walnut veneered plywood / Contreplaqué plaqué noyé  
Steel / Acier

**MANUFACTURING / ORIGINES**  
Made in Europe  
Metal parts : Lithuania, France  
Wood : Latvia

**DIMENSIONS**

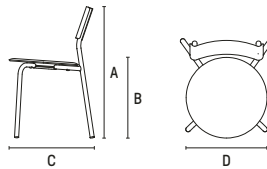

(A) Height / Hauteur : 82cm / 32.3in  
(B) Seat height / Hauteur d'assise : 46cm / 18.9in  
(C) Floor space / Emprise au sol : 48x54cm / 18.9x21.3in  
(D) Seat diameter / Diamètre d'assise : ø40cm / ø15.7in

**SPECIFICATIONS / SPÉCIFICITÉS**

Flat pack / Livraison à plat  
Max user load / Poids max utilisateur : 120kg / 264,61bs  
Stackable / Empilable : 6

**ECO IMPACT SCORE**



**SSDr recycled plastic chair**  
Chaise SSDr plastique recyclé



**MATERIALS / MATÉRIAUX**  
Recycled plastic (PP) / Plastique recyclé (PP)  
Steel / Acier

**MANUFACTURING / ORIGINES**  
Made in Europe  
Metal parts : Lithuania, France  
Recycled plastic : France

**DIMENSIONS**

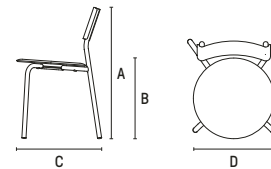

(A) Height / Hauteur : 82cm / 32.3in  
(B) Seat height / Hauteur d'assise : 46cm / 18.9in  
(C) Floor space / Emprise au sol : 48x54cm / 18.9x21.3in  
(D) Seat diameter / Diamètre d'assise : ø40cm / ø15.7in

**SPECIFICATIONS / SPÉCIFICITÉS**

Flat pack / Livraison à plat  
Max user load / Poids max utilisateur : 120kg / 264,61bs  
Stackable / Empilable : 6

**ECO IMPACT SCORE**



**SSD bar chair**  
Chaise de bar SSD



**MATERIALS / MATÉRIAUX**  
Oak veneered plywood «Oak» / Contreplaqué plaqué chêne «Chêne»  
Steel / Acier

**MANUFACTURING / ORIGINES**  
Made in Europe  
Metal parts : Lithuania, France  
Wood : Latvia

**SSDr recycled plastic bar chair**  
Chaise de bar SSDr plastique recyclé



**MATERIALS / MATÉRIAUX**  
Recycled plastic (PP) / Plastique recyclé (PP)  
Steel / Acier

**MANUFACTURING / ORIGINES**  
Made in Europe  
Metal parts : Lithuania, France  
Recycled plastic : France

**DIMENSIONS**

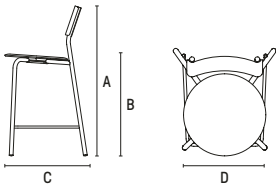

(A) Height / Hauteur : 105cm / 41.3in  
(B) Seat height / Hauteur d'assise : 66cm / 26in  
(C) Floor space / Emprise au sol : 55x54cm / 21.7x21.3in  
(D) Seat diameter / Diamètre d'assise : ø40cm / ø15.7in

(A) Height / Hauteur : 115cm / 45.3in  
(B) Seat height / Hauteur d'assise : 75cm / 29.5in  
(C) Floor space / Emprise au sol : 55x54cm / 21.7x21.3in  
(D) Seat diameter / Diamètre d'assise : ø40cm / ø15.7in

**SPECIFICATIONS / SPÉCIFICITÉS**

Flat pack / Livraison à plat  
Max user load / Poids max utilisateur : 120kg / 264,61bs  
Not stackable / Non empilable

**ECO IMPACT SCORE**



**DIMENSIONS**

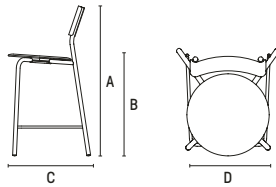

(A) Height / Hauteur : 105cm / 41.3in  
(B) Seat height / Hauteur d'assise : 66cm / 26in  
(C) Floor space / Emprise au sol : 55x54cm / 21.7x21.3in  
(D) Seat diameter / Diamètre d'assise : ø40cm / ø15.7in

(A) Height / Hauteur : 115cm / 45.3in  
(B) Seat height / Hauteur d'assise : 75cm / 29.5in  
(C) Floor space / Emprise au sol : 55x54cm / 21.7x21.3in  
(D) Seat diameter / Diamètre d'assise : ø40cm / ø15.7in

**SPECIFICATIONS / SPÉCIFICITÉS**

Flat pack / Livraison à plat  
Max user load / Poids max utilisateur : 120kg / 264,61bs  
Not stackable / Non empilable

**ECO IMPACT SCORE**



**SSD COLLECTION**  
by Tiptoe studio

**SSD Soft chair**  
Chaise SSD Soft

**Gabriel fabric**  
Tissu Gabriel

North America use rating

|             |   |
|-------------|---|
| RESIDENTIAL | • |
| CONTRACT    | • |

| Chair<br>Chaise                 | BACK & FABRIC SEAT<br>DOSSIER & ASSISE TEXTILE | Carbon black<br>Noir charbon | Sand beige<br>Beige sable |
|---------------------------------|--|------------------------------|---------------------------|
| FRAME<br>STRUCTURE              |  | ●                            | ●                         |
| Graphite black<br>Noir graphite | ●  | •                            |                           |
| Cream white<br>Blanc crème      | ○  |                              | •                         |

| Bar stool<br>Tabouret de bar       | SEAT<br>ASSISE | Oak / Chêne |
|------------------------------------|----------------|-------------|
| FRAME<br>STRUCTURE                 |                | ●           |
| Graphite black<br>Noir graphite    | ●              | •           |
| Cream white<br>Blanc crème         | ○              | •           |
| Eucalyptus grey<br>Gris eucalyptus | ●              | •           |

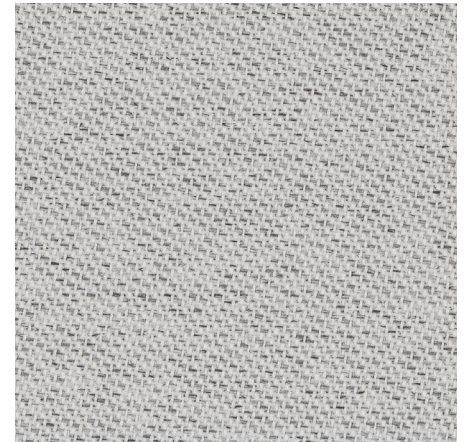

**MATERIALS / MATÉRIAUX**  
Gabriel recycled fabric / Tissu recyclé Gabriel  
Oak veneered plywood «Oak» / Contreplaqué plaqué chêne «Chêne»  
PU foam HR / Mousse PU HR  
Steel / Acier

**MANUFACTURING / ORIGINES**  
Made in Europe  
Metal parts : Lithuania, France  
Wood : Latvia  
Upholstery : Lithuania

**CYBER FABRIC RANGE / GAMME DE TISSU CYBER**  
Carbon black / Noir charbon : CYBER 3101  
Sand beige / Beige sable : CYBER 1101

**COMPOSITION**  
100% Post-consumer recycled polyester  
100% polyester recyclé post-consommation

**PILLING / BOULOCHAGE**  
4-5 (EN ISO 12945-2)

**RESISTANCE TO ABRASION AND FRICTION /  
RÉSISTANCE ABRASION ET FROTTEMENTS**  
120,000 Martindales (EN ISO 12947-2)  
4-5/4-5 (EN ISO 105x12)

**CERTIFICATES**  
EU Ecolabel Certified Fabrics  
OEKO-TEX® STANDARD 100

**DIMENSIONS**

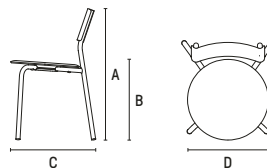

(A) Height / Hauteur : 82cm / 32.3in  
(B) Seat height / Hauteur d'assise : 50cm / 19.7in  
(C) Floor space / Emprise au sol : 48x54cm / 18.9x21.3in  
(D) Seat diameter / Diamètre d'assise : ø40cm / ø15.7in

**SPECIFICATIONS / SPÉCIFICITÉS**

Flat pack / Livraison à plat  
Max user load / Poids max utilisateur : 120kg / 264,61bs  
Stackable / Empilable : 6

**ECO IMPACT SCORE**



## SSD steel bar stool

Tabouret de bar SSD acier



### MATERIALS / MATÉRIAUX

Oak veneered plywood «Oak» / Contreplaqué plaqué chêne «Chêne»  
Steel / Acier

### MANUFACTURING / ORIGINES

Made in Europe  
Metal parts : Lithuania  
Wood : Latvia

### DIMENSIONS

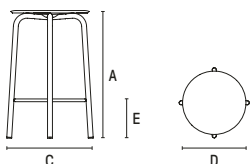

(A) Height / Hauteur : 65cm / 25.6in  
(C) Floor space / Emprise au sol : 33x33cm / 13x13in  
(D) Seat diameter / Diamètre d'assise : ø40cm / ø15.7in  
(E) Footrest height / Hauteur repose-pied : ø20cm / ø7.9in

(A) Height / Hauteur : 75cm / 29.5in  
(C) Floor space / Emprise au sol : 33x33cm / 13x13in  
(D) Seat diameter / Diamètre d'assise : ø40cm / ø15.7in  
(E) Footrest height / Hauteur repose-pied : ø30cm / ø11.8in

### SPECIFICATIONS / SPÉCIFICITÉS

Flat pack / Livraison à plat  
Max user load / Poids max utilisateur : 120kg / 264,61lbs  
Not stackable / Non empilable

### ECO IMPACT SCORE



**SSD FULL WOOD COLLECTION**  
by Tiptoe studio

North America use rating

|             |   |
|-------------|---|
| RESIDENTIAL | • |
| CONTRACT    | • |

| Chair<br>Chaise                 | Oak / Chêne | Tinted ash<br>Frêne teinté |
|---------------------------------|-------------|----------------------------|
| Natural oak<br>Chêne naturel    | •           | •                          |
| Graphite black<br>Noir graphite | •           | •                          |
| Fir green<br>Vert forêt         | •           | •                          |
| Poppy red<br>Rouge coquelicot   | •           | •                          |

| Stool<br>Tabouret                | Oak / Chêne | Tinted beech<br>Hêtre teinté |
|----------------------------------|-------------|------------------------------|
| Natural oak<br>Chêne naturel     | •           | •                            |
| Graphite black<br>Noir graphite  | •           | •                            |
| Pale blue<br>Bleu pâle           | •           | •                            |
| Brioche yellow<br>Jaune brioche  | •           | •                            |
| Tangerine red<br>Rouge tangerine | •           | •                            |

| Bar stool<br>Tabouret de bar | Oak veneered<br>Plaquage chêne |
|------------------------------|--------------------------------|
| Natural oak<br>Chêne naturel | •                              |

**SSD Full Wood chair**  
Chaise SSD Full Wood



**MATERIALS / MATÉRIAUX**

Oak veneered plywood «Oak» (seat & back) / Contreplaqué plaqué chêne «Chêne» (assise & dossier)  
Ash veneered plywood «Tinted ash» (seat & back) / Contreplaqué plaqué frêne «Frêne teinté» (assise & dossier)  
Solid wood (frame) / Bois massif (structure)

**MANUFACTURING / ORIGINES**

Made in Europe  
Wood : Latvia

**DIMENSIONS**

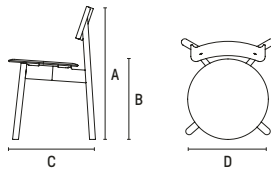

(A) Height / Hauteur : 78cm / 30.7in  
(B) Seat height / Hauteur d'assise : 45cm / 17.7in  
(C) Floor space / Emprise au sol : 48x51cm / 18.9x20.1in  
(D) Seat diameter / Diamètre d'assise : ø41cm / ø15.7in

**SPECIFICATIONS / SPÉCIFICITÉS**

Flat pack / Livraison à plat  
Max user load / Poids max utilisateur : 120kg / 264,61bs  
Stackable / Empilable : 3

**ECO IMPACT SCORE**



**SSD Full Wood stool**  
Tabouret SSD Full Wood



**MATERIALS / MATÉRIAUX**

Oak veneered plywood «Oak» (seat) / Contreplaqué plaqué chêne «Chêne» (assise)  
Beech veneered plywood «Tinted beech» (seat) / Contreplaqué plaqué hêtre «Hêtre teinté» (assise)  
Solid wood (frame) / Bois massif (structure)

**MANUFACTURING / ORIGINES**

Made in Europe  
Wood : Latvia

**DIMENSIONS**

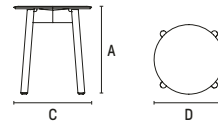

(A) Height / Hauteur : 45cm / 17.7in  
(C) Floor space / Emprise au sol : 33x33cm / 13x13in  
(D) Seat diameter / Diamètre d'assise : ø40cm / ø15.7in

**SPECIFICATIONS / SPÉCIFICITÉS**

Flat pack / Livraison à plat  
Max user load / Poids max utilisateur : 120kg / 264,61bs  
Not stackable / Non empilable

**ECO IMPACT SCORE**



SSD Full Wood bar stool  
Tabouret de bar SSD Full Wood



**MATERIALS / MATÉRIAUX**

Oak veneered plywood «Oak» (seat) / Contreplaqué  
plaqué chêne «Chêne» (assise)  
Solid oak (frame) / Chêne massif (structure)  
Steel / Acier

**MANUFACTURING / ORIGINES**

Made in Europe  
Metal parts : Lithuania  
Wood : Latvia

**DIMENSIONS**

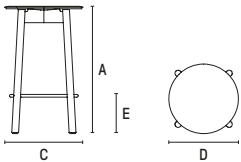

(A) Height / Hauteur : 65cm / 25.6in  
(C) Floor space / Emprise au sol : 33x33cm / 13x13in  
(D) Seat diameter / Diamètre d'assise : ø40cm / ø15.7in  
(E) Footrest height / Hauteur repose-pied : ø20cm / ø7.9in

(A) Height / Hauteur : 75cm / 29.7in  
(C) Floor space / Emprise au sol : 33x33cm / 13x13in  
(D) Seat diameter / Diamètre d'assise : ø40cm / ø15.7in  
(E) Footrest height / Hauteur repose-pied : ø30cm / ø11.8in

**SPECIFICATIONS / SPÉCIFICITÉS**

Flat pack / Livraison à plat  
Max user load / Poids max utilisateur : 120kg / 264,6lbs  
Not stackable / Non empilable

**ECO IMPACT SCORE**



**LOU COLLECTION**  
by Tiptoe studio

North America use rating

|             |   |
|-------------|---|
| RESIDENTIAL | • |
| CONTRACT    | • |

Stool  
Tabouret

| LEG<br>PIED                        | SEAT<br>ASSISE | Oak / Chêne | Tinted oak<br>Chêne teinté | Chroma Edition | Venezia | Macchiato |
|------------------------------------|----------------|-------------|----------------------------|----------------|---------|-----------|
| Graphite black<br>Noir graphite    | ●              | •           | •                          | •              | •       | •         |
| Cream white<br>Blanc crème         | ○              | •           | •                          | •              | •       | •         |
| Eucalyptus grey<br>Gris eucalyptus | ●              | •           | •                          | •              | •       | •         |
| Khaki green<br>Vert kaki           | ●              | •           | •                          | •              | •       | •         |
| Midnight blue<br>Bleu nuit         | ●              | •           | •                          | •              | •       | •         |
| Azure blue<br>Bleu Azur            | ●              | •           | •                          | •              | •       | •         |
| Pale blue<br>Bleu pâle             | ●              | •           | •                          | •              | •       | •         |
| Brioche yellow<br>Jaune brioche    | ●              | •           | •                          | •              | •       | •         |
| Tangerine red<br>Rouge tangerine   | ●              | •           | •                          | •              | •       | •         |

Bar stool  
Tabouret de bar

| LEG<br>PIED                        | SEAT<br>ASSISE | Oak / Chêne | Tinted oak<br>Chêne teinté | Venezia | Macchiato |
|------------------------------------|----------------|-------------|----------------------------|---------|-----------|
| Graphite black<br>Noir graphite    | ●              | •           | •                          | •       | •         |
| Cream white<br>Blanc crème         | ○              | •           | •                          | •       | •         |
| Eucalyptus grey<br>Gris eucalyptus | ●              | •           | •                          | •       | •         |
| Khaki green<br>Vert kaki           | ●              | •           | •                          | •       | •         |

SEAT THICKNESS / ÉPAISSEUR ASSISE

Oak / Chêne : 3,2cm / 1.3in  
 Tinted oak / Chêne teinté : 3,2cm / 1.3in  
 Monochrome : 3,2cm / 1.3in  
 Venezia rec. plas. / Plas. rec. Venezia : 3,2cm / 1.3in  
 Macchiato rec. plas. / Plas. rec. Macchiato : 3,2cm / 1.3in

VENEZIA RECYCLED PLASTIC  
HIPS (High Impact Polystyrene)



MACCHIATO RECYCLED PLASTIC  
HIPS (High Impact Polystyrene)



Lou stool  
Tabouret Lou



MATERIALS / MATÉRIAUX

Steel / Acier  
 Solid oak «Oak» / Chêne massif «Chêne»  
 Solid oak «Tinted oak» / Chêne massif «Chêne teinté»  
 HIPS (High Impact Polystyrene) «Venezia» & «Macchiato»

MANUFACTURING / ORIGINES

Made in Europe  
 Metal parts : Bulgaria, France  
 Wood : Czech Republic  
 Recycled plastic : UK

DIMENSIONS

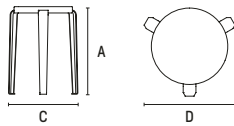

(A) Height / Hauteur : 45cm / 17.7in  
 (C) Floor space / Emprise au sol : 35,6x30cm / 13.8x11.8in  
 (D) Seat diameter / Diamètre d'assise : ø30cm / ø11.8in

SPECIFICATIONS / SPÉCIFICITÉS

Flat pack / Livraison à plat  
 Max user load / Poids max utilisateur : 120kg / 264,6lbs  
 Stackable / Empilable : 7

ECO IMPACT SCORE



Lou stool - Chroma Edition  
Tabouret Lou - Edition Chroma



MATERIALS / MATÉRIAUX

Steel / Acier  
 Tinted solid beech «Chroma Edition» / Hêtre massif teinté «Edition Chroma»

MANUFACTURING / ORIGINES

Made in Europe  
 Metal parts : Bulgaria, France  
 Wood : Czech Republic

DIMENSIONS

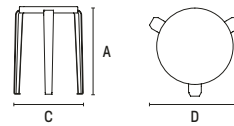

(A) Height / Hauteur : 45cm / 17.7in  
 (C) Floor space / Emprise au sol : 35,6x30cm / 13.8x11.8in  
 (D) Seat diameter / Diamètre d'assise : ø30cm / ø11.8in

SPECIFICATIONS / SPÉCIFICITÉS

Flat pack / Livraison à plat  
 Max user load / Poids max utilisateur : 120kg / 264,6lbs  
 Stackable / Empilable : 7

ECO IMPACT SCORE



**Lou bar stool**  
Tabouret de bar Lou



**MATERIALS / MATÉRIAUX**  
Steel / Acier  
Solid oak «Oak» / Chêne massif «Chêne»  
Solid oak «Tinted oak» / Chêne massif «Chêne teinté»  
HIPS (High Impact Polystyrene) «Venezia» & «Macchiato»

**MANUFACTURING / ORIGINES**  
Made in Europe  
Metal parts : Bulgaria, France  
Wood : Czech Republic  
Recycled plastic : UK

**DIMENSIONS**

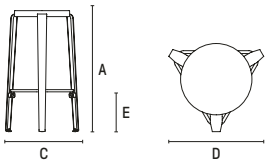

(A) Height / Hauteur : 65cm / 25.6in  
(C) Floor space / Emprise au sol : 40x30cm / 15.7x11.8in  
(D) Seat diameter / Diamètre d'assise : ø30cm / ø11.8in  
(E) Footrest height / Hauteur repose-pied : ø23cm / ø9in

(A) Height / Hauteur : 75cm / 29.5in  
(C) Floor space / Emprise au sol : 40x30cm / 15.7x11.8in  
(D) Seat diameter / Diamètre d'assise : ø30cm / ø11.8in  
(E) Footrest height / Hauteur repose-pied : ø26cm / ø10.2in

**SPECIFICATIONS / SPÉCIFICITÉS**

Flat pack / Livraison à plat  
Max user load / Poids max utilisateur : 120kg / 264,6lbs  
Not stackable / Non empilable

**ECO IMPACT SCORE**



**Lou bench**  
Banc Lou



| LEG<br>PIED                        | SEAT<br>ASSISE | Oak / Chêne |
|------------------------------------|----------------|-------------|
| Graphite black<br>Noir graphite    | ●              | ●           |
| Cream white<br>Blanc crème         | ○              | ●           |
| Eucalyptus grey<br>Gris eucalyptus | ●              | ●           |

SEAT THICKNESS / ÉPAISSEUR ASSISE  
Oak / Chêne : 3,2cm / 1.3in

**MATERIALS / MATÉRIAUX**  
Solid oak «Oak» / Chêne massif «Chêne»  
Steel / Acier

**MANUFACTURING / ORIGINES**  
Made in Europe  
Metal parts : Bulgaria  
Wood : Croatia

**DIMENSIONS**

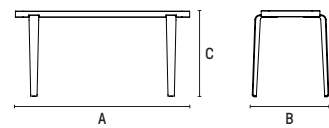

(A) Length / Longueur : 90cm / 35.4in  
(B) Width / Largeur : 30cm / 11.8in  
(C) Height / Hauteur : 45cm / 17.7in

(A) Length / Longueur : 140cm / 55.1in  
(B) Width / Largeur : 30cm / 11.8in  
(C) Height / Hauteur : 45cm / 17.7in

(A) Length / Longueur : 170cm / 66.9in  
(B) Width / Largeur : 30cm / 11.8in  
(C) Height / Hauteur : 45cm / 17.7in

**SPECIFICATIONS / SPÉCIFICITÉS**

Flat pack / Livraison à plat  
Max user load / Poids max utilisateur : 120kg / 264,6lbs  
Not stackable / Non empilable

**ECO IMPACT SCORE**



ETUDE COLLECTION  
by Tiptoe studio

North America use rating

|             |   |
|-------------|---|
| RESIDENTIAL | ● |
| CONTRACT    | ● |

| Chair<br>Chaise                 | BACK & SEAT<br>DOSSIER & ASSISE | Oak /Chêne | Carbon black<br>Noir charbon | Sand beige<br>Beige sable |
|---------------------------------|---------------------------------|------------|------------------------------|---------------------------|
| FRAME<br>STRUCTURE              |                                 | ●          | ●                            | ●                         |
| Graphite black<br>Noir graphite | ●                               | ●          | ●                            | ●                         |
| Cream white<br>Blanc crème      | ○                               | ●          | ●                            | ●                         |

| Armchair<br>Chaise accoudoirs   | BACK & SEAT<br>DOSSIER & ASSISE | Oak /Chêne | Carbon black<br>Noir charbon | Sand beige<br>Beige sable |
|---------------------------------|---------------------------------|------------|------------------------------|---------------------------|
| FRAME<br>STRUCTURE              |                                 | ●          | ●                            | ●                         |
| Graphite black<br>Noir graphite | ●                               | ●          | ●                            | ●                         |
| Cream white<br>Blanc crème      | ○                               | ●          | ●                            | ●                         |

Etude chair  
Chaise Etude



MATERIALS / MATÉRIAUX  
Oak veneered plywood «Oak» / Contreplaqué plaqué chêne «Chêne»  
Steel / Acier

MANUFACTURING / ORIGINES  
Made in Europe  
Metal parts : Lithuania  
Wood : Latvia  
Upholstery : Lithuania

Etude armchair  
Chaise accoudoirs Etude



MATERIALS / MATÉRIAUX  
Oak veneered plywood «Oak» / Contreplaqué plaqué chêne «Chêne»  
Steel / Acier

MANUFACTURING / ORIGINES  
Made in Europe  
Metal parts : Lithuania  
Wood : Latvia  
Upholstery : Lithuania

DIMENSIONS

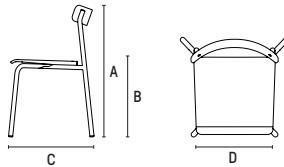

(A) Height / Hauteur : 79cm / 31.1in  
(B) Seat height / Hauteur d'assise : 46cm / 18.1in  
(C) Floor space / Emprise au sol : 43x55cm / 16.9x21.7in  
(D) Seat / Assise : 38x40cm / 15x15.7in

FABRIC OPTION / OPTION TISSU



SPECIFICATIONS / SPÉCIFICITÉS

Flat pack / Livraison à plat  
Max user load / Poids max utilisateur : 120kg / 264,61bs  
Stackable / Empilable : 4

ECO IMPACT SCORE



DIMENSIONS

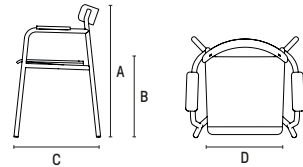

(A) Height / Hauteur : 79cm / 31.1in  
(B) Seat height / Hauteur d'assise : 46cm / 18.1in  
(C) Floor space / Emprise au sol : 53x55cm / 20.9x21.7in  
(D) Seat / Assise : 38x40cm / 15x15.7in

FABRIC OPTION / OPTION TISSU



SPECIFICATIONS / SPÉCIFICITÉS

Not flat pack / Non livré à plat  
Max user load / Poids max utilisateur : 120kg / 264,61bs  
Stackable / Empilable : 4

ECO IMPACT SCORE



Monochrome Etude chair  
Chaise monochrome Etude

Monochrome Etude armchair  
Chaise accoudoirs monochrome Etude

|                                 |                                 |                            |
|---------------------------------|---------------------------------|----------------------------|
| Chair<br>Chaise                 | SEAT & BACK<br>ASSISE & DOSSIER |                            |
| FRAME<br>STRUCTURE              | Tinted ash<br>Frêne teinté      | Tinted ash<br>Frêne teinté |
| Graphite black<br>Noir graphite | ●                               | ●                          |
| Rock blue<br>Bleu roche         | ●                               | ●                          |
| Armchair<br>Chaise accoudoirs   | SEAT & BACK<br>ASSISE & DOSSIER |                            |
| FRAME<br>STRUCTURE              | Tinted ash<br>Frêne teinté      | Tinted ash<br>Frêne teinté |
| Graphite black<br>Noir graphite | ●                               | ●                          |



**MATERIALS / MATÉRIAUX**  
Ash veneered plywood «Tinted ash» / Contreplaqué plaqué frêne «Frêne teinté»  
Steel / Acier

**MANUFACTURING / ORIGINES**  
Made in Europe  
Metal parts : Lithuania  
Wood : Latvia

**MATERIALS / MATÉRIAUX**  
Ash veneered plywood «Tinted ash» / Contreplaqué plaqué frêne «Frêne teinté»  
Steel / Acier

**MANUFACTURING / ORIGINES**  
Made in Europe  
Metal parts : Lithuania  
Wood : Latvia

**DIMENSIONS**

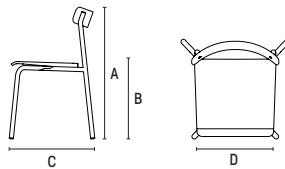

(A) Height / Hauteur : 79cm / 31.1in  
(B) Seat height / Hauteur d'assise : 46cm / 18.1in  
(C) Floor space / Emprise au sol : 43x55cm / 16.9x21.7in  
(D) Seat / Assise : 38x40cm / 15x15.7in

**DIMENSIONS**

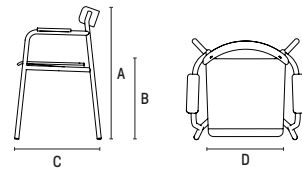

(A) Height / Hauteur : 79cm / 31.1in  
(B) Seat height / Hauteur d'assise : 46cm / 18.1in  
(C) Floor space / Emprise au sol : 53x55cm / 20.9x21.7in  
(D) Seat / Assise : 38x40cm / 15x15.7in

**SPECIFICATIONS / SPÉCIFICITÉS**

Flat pack / Livraison à plat  
Max user load / Poids max utilisateur : 120kg / 264,61bs  
Stackable / Empilable : 4

**SPECIFICATIONS / SPÉCIFICITÉS**

Not flat pack / Non livré à plat  
Max user load / Poids max utilisateur : 120kg / 264,61bs  
Stackable / Empilable : 4

**ECO IMPACT SCORE**



**ECO IMPACT SCORE**



ETUDE COLLECTION  
by Tiptoe studio

North America use rating

|             |   |
|-------------|---|
| RESIDENTIAL | • |
| CONTRACT    | • |

Lounge chair  
Chaise lounge

FRAME  
STRUCTURE

Graphite black  
Noir graphite

SEAT & BACK  
ASSISE & DOSSIER

• Oak / Chêne

Lounge armchair  
Lounge accoudoirs

FRAME  
STRUCTURE

Graphite black  
Noir graphite

BACK & SEAT  
DOSSIER & ASSISE

• Oak / Chêne

• Carbon black  
Noir charbon

• Sand beige  
Beige sable

Etude lounge chair  
Chaise lounge Etude



MATERIALS / MATÉRIAUX

Oak veneered plywood «Oak» / Contreplaqué plaqué chêne «Chêne»  
Steel / Acier

MANUFACTURING / ORIGINES

Made in Europe  
Metal parts : Lithuania  
Wood : Latvia

DIMENSIONS

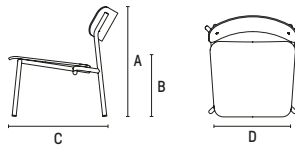

(A) Height / Hauteur : 68cm / 26.8in  
(B) Seat height / Hauteur d'assise : 37cm / 14.6in  
(C) Floor space / Emprise au sol : 49x59cm / 19.3x23.2in  
(D) Seat / Assise : 50x51cm / 19.7x20.1in

SPECIFICATIONS / SPÉCIFICITÉS

Not flat pack / Non livré à plat  
Max user load / Poids max utilisateur : 120kg / 264,61bs  
Not stackable / Non empilable

ECO IMPACT SCORE



Etude lounge armchair  
Chaise accoudoirs lounge Etude



MATERIALS / MATÉRIAUX

Oak veneered plywood «Oak» / Contreplaqué plaqué chêne «Chêne»  
Steel / Acier

MANUFACTURING / ORIGINES

Made in Europe  
Metal parts : Lithuania  
Wood : Latvia  
Upholstery : Lithuania

DIMENSIONS

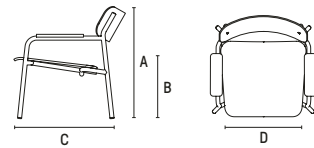

(A) Height / Hauteur : 68cm / 26.8in  
(B) Seat height / Hauteur d'assise : 37cm / 14.6in  
(C) Floor space / Emprise au sol : 68x59cm / 26.8x23.2in  
(D) Seat / Assise : 50x51cm / 19.7x20.1in

FABRIC OPTION / OPTION TISSU



SPECIFICATIONS / SPÉCIFICITÉS

Not flat pack / Non livré à plat  
Max user load / Poids max utilisateur : 120kg / 264,61bs  
Not stackable / Non empilable

ECO IMPACT SCORE



Gabriel fabric  
Tissu Gabriel

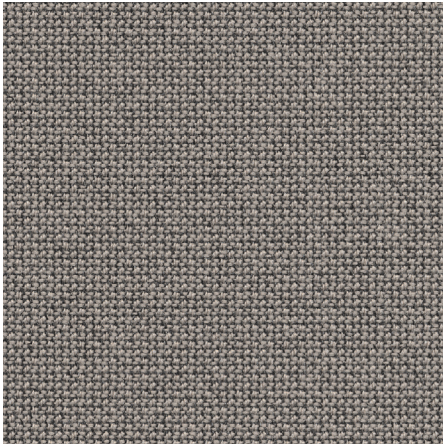

CYBER FABRIC RANGE / GAMME DE TISSU CYBER  
Carbon black / Noir charbon : CYBER 3101  
Sand beige / Beige sable : CYBER 1101

COMPOSITION  
100% Post-consumer recycled polyester  
100 % polyester recyclé post-consommation

PILLING / BOULOCHAGE  
4-5 (EN ISO 12945-2)

RESISTANCE TO ABRASION AND FRICTION /  
RÉSISTANCE ABRASION ET FROTTEMENTS  
120,000 martindale (EN ISO 12947-2)  
4-5/4-5 (EN ISO 105x12)

CERTIFICATES  
EU Ecolabel Certified Fabrics  
OEKO-TEX® STANDARD 100

## WALL BRACKET & JO WALL HOOK COLLECTION

BESPOKE OPTIONS AVAILABLE  
SUR-MESURE DISPONIBLE 



Wall bracket



Bedside shelf



Bookshelf

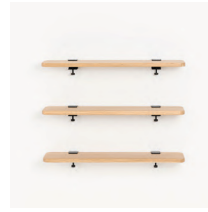

Bookshelves



Jo wall hook

## PLI COLLECTION

BESPOKE OPTIONS AVAILABLE  
SUR-MESURE DISPONIBLE 



Wall shelf



Slim wall shelf



Floating shelf



Coat hook add-on



# SHELVING ÉTAGÈRE



**WALL BRACKET & JO WALL HOOK**  
COLLECTION by Tiptoe studio

North America use rating

|             |   |
|-------------|---|
| RESIDENTIAL | • |
| CONTRACT    | • |

|                                    |   | Wall Bracket | Jo wall hook |
|------------------------------------|---|--------------|--------------|
| Graphite black<br>Noir graphite    | ● | •            | •            |
| Cream white<br>Blanc crème         | ○ | •            | •            |
| Eucalyptus grey<br>Gris eucalyptus | ● | •            | •            |
| Khaki green<br>Vert kaki           | ● | •            | •            |
| Midnight blue<br>Bleu nuit         | ● | •            | •            |
| Azure blue<br>Bleu azur            | ● |              |              |
| Pale blue<br>Bleu pâle             | ● | •            |              |
| Brioche yellow<br>Jaune brioche    | ● |              | •            |
| Tangerine red<br>Rouge tangerine   | ● | •            |              |

| TABLETOP<br>PLATEAU                      | SIZE<br>TAILLE | 32x27cm / 12.6x10.6in | 45x20cm / 17.7x7.9in | 60x20cm / 23.6x7.9in | 90x20cm / 35.4x7.9in | 120x20cm / 47.2x7.9in | 150x20cm / 59.1x7.9in |
|--|----------------|-----------------------|----------------------|----------------------|----------------------|-----------------------|-----------------------|
| Oak<br>Chêne                             | ●              | •                     | •                    | •                    | •                    | •                     | •                     |
| Old oak<br>Bois ancien                   | ●              | •                     | •                    | •                    | •                    | •                     | •                     |
| Venezia rec. plas.<br>Plas. rec. Venezia | ○              | •                     | •                    | •                    | •                    | •                     | •                     |

TABLE TOP THICKNESS / ÉPAISSEUR PLATEAU

Oak / Chêne : 2cm / 0.8in  
Old oak / Bois ancien : 2,5cm / 1in  
Venezia rec. plas. / Plas. rec. Venezia : 2cm / 0.8in

VENEZIA RECYCLED PLASTIC

HIPS (High Impact Polystyrene)

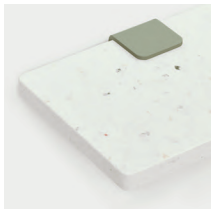

**Wall Bracket**  
Accroche murale Bracket



MATERIALS / MATÉRIAUX

Aluminium  
Steel / Acier

MANUFACTURING / ORIGINES

Made in Europe  
Metal parts : Bulgaria, France

DIMENSIONS

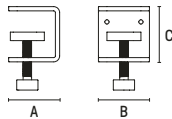

(A) Length / Longueur : 6cm / 2.4in  
(B) Width / Largeur : 6cm / 2.4in  
(C) Height / Hauteur : 6,5cm / 2.4in

SPECIFICATIONS / SPÉCIFICITÉS

Flat pack / Livraison à plat  
Maximum load / Charge maximale : 7kg / 15,4lbs

ECO IMPACT SCORE

Not rated yet / Non évalué à date

**Bedside shelf**  
Table de chevet



MATERIALS / MATÉRIAUX

Steel / Acier  
Aluminium

Shelf options:

Oak veneered plywood «Oak» / Contreplaqué plaqué chêne «Chêne»  
Solid oak «Old oak» / Chêne massif «Bois ancien»  
HIPS (High Impact Polystyrene) «Venezia»

MANUFACTURING / ORIGINES

Made in Europe  
Metal parts : Bulgaria, France  
Wood : Croatia  
Recycled plastic : UK

DIMENSIONS

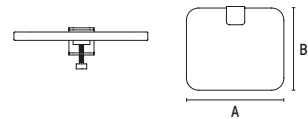

(A) Length / Longueur : 32cm / 12.6in  
(B) Width / Largeur : 27cm / 10.6in

(A) Length / Longueur : 45cm / 17.7in  
(B) Width / Largeur : 20cm / 7.9in

SPECIFICATIONS / SPÉCIFICITÉS

Flat pack / Livraison à plat  
Maximum load / Charge maximale : 7kg / 15.4lbs

ECO IMPACT SCORE



**Book shelf**  
Bibliothèque murale



**MATERIALS / MATÉRIAUX**

Steel / Acier  
Aluminium

Shelf options:

Oak veneered plywood «Oak» / Contreplaqué plaqué chêne «Chêne»  
Solid oak «Old oak» / Chêne massif «Bois ancien»  
HIPS (High Impact Polystyrene) «Venezia»

**MANUFACTURING / ORIGINES**

Made in Europe  
Metal parts : Bulgaria, France  
Wood : Croatia  
Recycled plastic : UK

**DIMENSIONS**

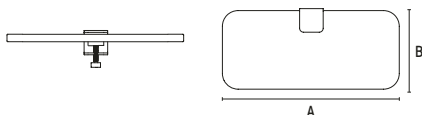

(A) Length / Longueur : 60cm / 23.6in  
(B) Width / Largeur : 20cm / 7.9in

(A) Length / Longueur : 90cm / 35.4in  
(B) Width / Largeur : 20cm / 7.9in

(A) Length / Longueur : 120cm / 47.2in  
(B) Width / Largeur : 20cm / 7.9in

(A) Length / Longueur : 150cm / 59.1in  
(B) Width / Largeur : 20cm / 7.9in

**SPECIFICATIONS / SPÉCIFICITÉS**

Flat pack / Livraison à plat  
Maximum load / Charge maximale : 14kg / 30.9lbs

**ECO IMPACT SCORE**



**Jo wall hook**  
Patère Jo



**MATERIALS / MATÉRIAUX**

Steel / Acier

**MANUFACTURING / ORIGINES**

Made in Europe  
Metal parts : Bulgaria, France

**DIMENSIONS**

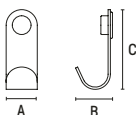

(A) Length / Longueur : 5cm / 2in  
(B) Width / Largeur : 5,5cm / 2in  
(C) Height / Hauteur : 15cm / 5,9in

**SPECIFICATIONS / SPÉCIFICITÉS**

Flat pack / Livraison à plat  
Maximum load / Charge maximale : 10kg / 22lbs

**ECO IMPACT SCORE**

Not rated yet / Non évalué à date

**PLI COLLECTION**  
by Tiptoe studio

North America use rating

|             |   |
|-------------|---|
| RESIDENTIAL | • |
| CONTRACT    | • |

|                                    | Wall shelf<br>Étagère murale | Floating shelf<br>Tablette murale | Slim wall shelf<br>Étagère murale | Coat hook add on<br>Crochet étagère |
|------------------------------------|------------------------------|-----------------------------------|-----------------------------------|-------------------------------------|
| Graphite black<br>Noir graphite    | ●                            | •                                 |                                   |                                     |
| Cream white<br>Blanc crème         | ○                            | •                                 | •                                 | •                                   |
| Eucalyptus grey<br>Gris eucalyptus | ●                            | •                                 | •                                 | •                                   |
| Azure blue<br>Bleu azur            | ●                            | •                                 | •                                 | •                                   |
| Pale blue<br>Bleu pâle             | ●                            | •                                 |                                   |                                     |
| Rock blue<br>Bleu roche            | ●                            | •                                 |                                   |                                     |
| Tangerine red<br>Rouge tangerine   | ●                            | •                                 |                                   |                                     |
| Powder pink<br>Rose poudré         | ●                            | •                                 |                                   |                                     |
| Naples yellow<br>Jaune de Naples   | ●                            | •                                 | •                                 | •                                   |

**Wall shelf**  
Étagère murale



**MATERIALS / MATÉRIAUX**  
Steel / Acier

**MANUFACTURING / ORIGINES**  
Made in Europe  
Metal parts : Lithuania, France

**Slim wall shelf**  
Étagère murale slim



**MATERIALS / MATÉRIAUX**  
Steel / Acier

**MANUFACTURING / ORIGINES**  
Made in Europe  
Metal parts : Lithuania, France

**DIMENSIONS**

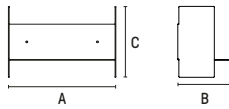

(A) Length / Longueur : 20cm / 7.9in  
(B) Width / Largeur : 15cm / 5.9in  
(C) Height / Hauteur : 20cm / 7.9in

(A) Length / Longueur : 30cm / 11.8in  
(B) Width / Largeur : 15cm / 5.9in  
(C) Height / Hauteur : 20cm / 7.9in

(A) Length / Longueur : 45cm / 17.7in  
(B) Width / Largeur : 15cm / 5.9in  
(C) Height / Hauteur : 20cm / 7.9in

(A) Length / Longueur : 60cm / 23.6in  
(B) Width / Largeur : 15cm / 5.9in  
(C) Height / Hauteur : 20cm / 7.9in

**SPECIFICATIONS / SPÉCIFICITÉS**

Not flat pack / Non livré à plat  
Maximum load / Charge maximale : 15kg / 33lbs

**ECO IMPACT SCORE**



**DIMENSIONS**

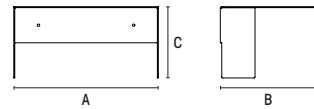

(A) Length / Longueur : 20cm / 7.9in  
(B) Width / Largeur : 20cm / 7.9in  
(C) Height / Hauteur : 15cm / 5.9in

(A) Length / Longueur : 30cm / 11.8in  
(B) Width / Largeur : 20cm / 7.9in  
(C) Height / Hauteur : 15cm / 5.9in

(A) Length / Longueur : 45cm / 17.7in  
(B) Width / Largeur : 20cm / 7.9in  
(C) Height / Hauteur : 15cm / 5.9in

(A) Length / Longueur : 60cm / 23.6in  
(B) Width / Largeur : 20cm / 7.9in  
(C) Height / Hauteur : 15cm / 5.9in

**SPECIFICATIONS / SPÉCIFICITÉS**

Not flat pack / Non livré à plat  
Maximum load / Charge maximale : 10kg / 22lbs

**ECO IMPACT SCORE**



**Floating shelf**  
Tablette murale



**MATERIALS / MATÉRIAUX**  
Steel / Acier

**MANUFACTURING / ORIGINES**  
Made in Europe  
Metal parts : Lithuania, France

**DIMENSIONS**

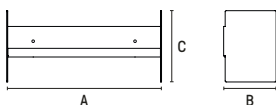

(A) Length / Longueur : 20cm / 7.9in  
(B) Width / Largeur : 10cm / 3.9in  
(C) Height / Hauteur : 14cm / 5.5in

(A) Length / Longueur : 30cm / 11.8in  
(B) Width / Largeur : 10cm / 3.9in  
(C) Height / Hauteur : 14cm / 5.5in

(A) Length / Longueur : 45cm / 17.7in  
(B) Width / Largeur : 10cm / 3.9in  
(C) Height / Hauteur : 14cm / 5.5in

(A) Length / Longueur : 60cm / 23.6in  
(B) Width / Largeur : 10cm / 3.9in  
(C) Height / Hauteur : 14cm / 5.5in

**SPECIFICATIONS / SPÉCIFICITÉS**  
Not flat pack / Non livré à plat  
Maximum load / Charge maximale : 15kg / 33lbs

**ECO IMPACT SCORE**



**Coat hook add-on\***  
Crochet pour étagère



\*Add on for wall shelf and Slim wall shelf  
Crochet disponible pour l'étagère Pli et Pli Slim

**MATERIALS / MATÉRIAUX**  
Steel / Acier

**MANUFACTURING / ORIGINES**  
Made in Europe  
Metal parts : Lithuania, France

**DIMENSIONS**

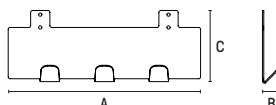

(A) Length / Longueur : 20cm / 7.9in  
(B) Width / Largeur : 3cm / 1.2in  
(C) Height / Hauteur : 10cm / 3.9in

(A) Length / Longueur : 30cm / 11.8in  
(B) Width / Largeur : 3cm / 1.2in  
(C) Height / Hauteur : 10cm / 3.9in

(A) Length / Longueur : 45cm / 17.7in  
(B) Width / Largeur : 3cm / 1.2in  
(C) Height / Hauteur : 10cm / 3.9in

(A) Length / Longueur : 60cm / 23.6in  
(B) Width / Largeur : 3cm / 1.2in  
(C) Height / Hauteur : 10cm / 3.9in

**SPECIFICATIONS / SPÉCIFICITÉS**  
Not flat pack / Non livré à plat  
Maximum load / Charge maximale : 10kg / 22lbs

**ECO IMPACT SCORE**



**WALL-MOUNTED COAT RACK**  
ÉTAGÈRE PORTE-MANTEAU

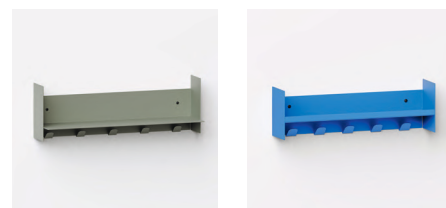

## UNIT SYSTEM COLLECTION

BESPOKE OPTIONS AVAILABLE  
SUR-MESURE DISPONIBLE 



UNIT 01



UNIT 02



UNIT 03



UNIT 05



UNIT 06



UNIT office



Selected configurations



## UNIT STEEL SYSTEM COLLECTION

BESPOKE OPTIONS AVAILABLE  
SUR-MESURE DISPONIBLE 



UNIT 01



UNIT 02



UNIT 03



UNIT 05



UNIT 06



Selected configurations



# STORAGE RANGEMENT



UNIT SYSTEM COLLECTION  
by Tiptoe studio

UNIT 01

UNIT 02

North America use rating

|             |   |
|-------------|---|
| RESIDENTIAL | • |
| CONTRACT    | • |

|                                 |                  |            |
|---------------------------------|------------------|------------|
| FRAME<br>STRUCTURE              | SHELF<br>ÉTAGÈRE | Oak /Chêne |
| Graphite black<br>Noir graphite | ●                | •          |
| Cream white<br>Blanc crème      | ○                | •          |



**MATERIALS / MATÉRIAUX**  
Oak veneered chipboard / Bois aggloméré plaqué chêne  
Steel / Acier

**MANUFACTURING / ORIGINES**  
Made in Europe  
Metal parts : Lithuania  
Wood : Bosnia

**MATERIALS / MATÉRIAUX**  
Oak veneered chipboard / Bois aggloméré plaqué chêne  
Steel / Acier

**MANUFACTURING / ORIGINES**  
Made in Europe  
Metal parts : Lithuania  
Wood : Bosnia

DIMENSIONS

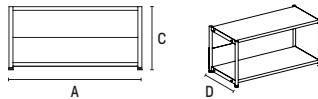

(A) Length / Longueur : 84cm / 33.1in  
(C) Height / Hauteur : 40cm / 15.7in  
(D) Depth / Profondeur : 42cm / 16.5in

DIMENSIONS

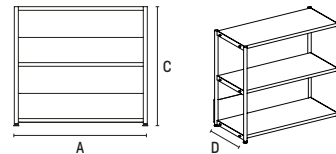

(A) Length / Longueur : 84cm / 33.1in  
(C) Height / Hauteur : 75cm / 29.5in  
(D) Depth / Profondeur : 42cm / 16.5in

SPECIFICATIONS / SPÉCIFICITÉS

Flat pack / Livraison à plat  
Maximum load / Charge maximale : 30kg / 66lbs  
Adjustable foot / Vérins réglables : 1cm / 0.4in

SPECIFICATIONS / SPÉCIFICITÉS

Flat pack / Livraison à plat  
Maximum load / Charge maximale : 30kg / 66lbs  
Adjustable foot / Vérins réglables : 1cm / 0.4in

ECO IMPACT SCORE



ECO IMPACT SCORE



## UNIT 03



**MATERIALS / MATÉRIAUX**  
Oak veneered chipboard / Bois aggloméré plaqué chêne  
Steel / Acier

**MANUFACTURING / ORIGINES**  
Made in Europe  
Metal parts : Lithuania  
Wood : Bosnia

### DIMENSIONS

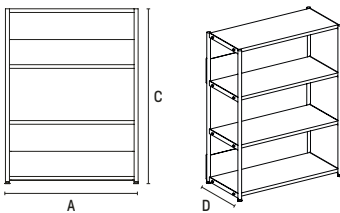

(A) Length / Longueur : 84cm / 33.1in  
(C) Height / Hauteur : 110cm / 43.3in  
(D) Depth / Profondeur : 42cm / 16.5in

### SPECIFICATIONS / SPÉCIFICITÉS

Flat pack / Livraison à plat  
Maximum load / Charge maximale : 30kg / 66lbs  
Adjustable foot / Vérins réglables : 1cm / 0.4in

### ECO IMPACT SCORE



## UNIT 05



**MATERIALS / MATÉRIAUX**  
Oak veneered chipboard / Bois aggloméré plaqué chêne  
Steel / Acier

**MANUFACTURING / ORIGINES**  
Made in Europe  
Metal parts : Lithuania  
Wood : Bosnia

### DIMENSIONS

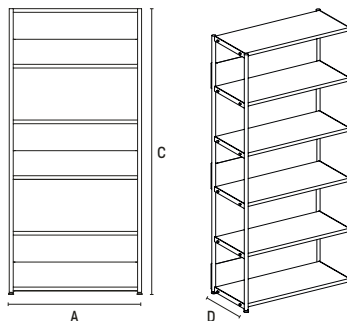

(A) Length / Longueur : 84cm / 33.1in  
(C) Height / Hauteur : 180cm / 70.9in  
(D) Depth / Profondeur : 42cm / 16.5in

### SPECIFICATIONS / SPÉCIFICITÉS

Flat pack / Livraison à plat  
Maximum load / Charge maximale : 30kg / 66lbs  
Adjustable foot / Vérins réglables : 1cm / 0.4in

### ECO IMPACT SCORE



## UNIT 06



**MATERIALS / MATÉRIAUX**  
Oak veneered chipboard / Bois aggloméré plaqué chêne  
Steel / Acier

**MANUFACTURING / ORIGINES**  
Made in Europe  
Metal parts : Lithuania  
Wood : Bosnia

### DIMENSIONS

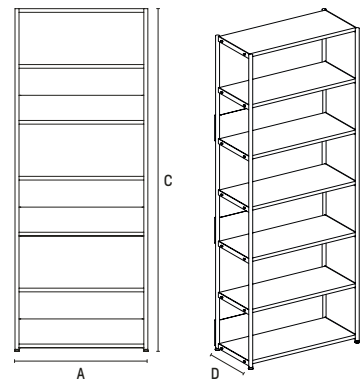

(A) Length / Longueur : 84cm / 33.1in  
(C) Height / Hauteur : 215cm / 84.6in  
(D) Depth / Profondeur : 42cm / 16.5in

### SPECIFICATIONS / SPÉCIFICITÉS

Flat pack / Livraison à plat  
Maximum load / Charge maximale : 30kg / 66lbs  
Adjustable foot / Vérins réglables : 1cm / 0.4in

### ECO IMPACT SCORE



## UNIT office



**MATERIALS / MATÉRIAUX**  
Oak veneered chipboard / Bois aggloméré plaqué chêne  
Steel / Acier

**MANUFACTURING / ORIGINES**  
Made in Europe  
Metal parts : Lithuania  
Wood : Bosnia

## Work shelf Tablette de bureau



**MATERIALS / MATÉRIAUX**  
Oak veneered chipboard / Bois aggloméré plaqué chêne  
Steel / Acier

**MANUFACTURING / ORIGINES**  
Made in Europe  
Metal parts : Lithuania  
Wood : Bosnia

## Cabinet door & drawer Bloc porte & tiroir



**MATERIALS / MATÉRIAUX**  
Oak veneered chipboard / Bois aggloméré plaqué chêne  
Steel / Acier

**MANUFACTURING / ORIGINES**  
Made in Europe  
Metal parts : Lithuania  
Wood : Bosnia

### DIMENSIONS

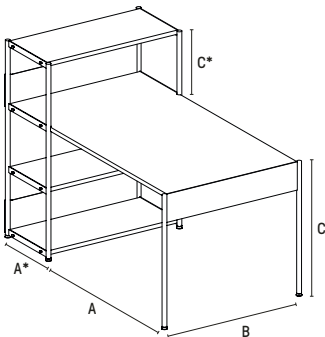

(A) Length / Longueur : 110cm / 43.3in  
(A\*) Length / Longueur : 42cm / 16.5in  
(B) Width / Largeur : 85cm / 33.5in  
(C) Height / Hauteur : 75cm / 29.5in  
(C\*) Height / Hauteur : 35cm / 13.8in

### SPECIFICATIONS / SPÉCIFICITÉS

Flat pack / Livraison à plat  
Maximum load / Charge maximale : 30kg / 66lbs  
Adjustable foot / Vêrins réglables : 1cm / 0.4in

### ECO IMPACT SCORE



### DIMENSIONS

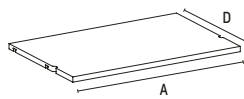

(A) Length / Longueur : 80cm / 31.5in  
(D) Depth / Profondeur : 51cm / 20.1in  
Tabletop thickness / Épaisseur plateau : 2,3cm / 0.8in

### SPECIFICATIONS / SPÉCIFICITÉS

Flat pack / Livraison à plat  
Maximum load / Charge maximale : 30kg / 66lbs

### ECO IMPACT SCORE



### DIMENSIONS

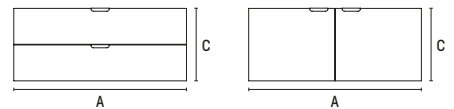

(A) Length / Longueur : 80cm / 31.5in  
(C) Height / Hauteur : 37cm / 14.6in

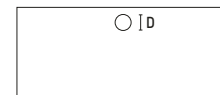

Cable hole for cabinet doors / Passe câble pour le bloc porte  
(D) Diameter / Diamètre : ø5cm / ø2in

### SPECIFICATIONS / SPÉCIFICITÉS

Flat pack / Livraison à plat

### ECO IMPACT SCORE

Not rated yet / Non évalué à date

Wardrobe  
Penderie

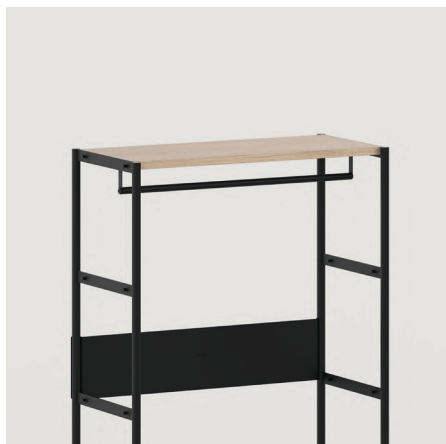

MATERIALS / MATÉRIAUX  
Steel / Acier

MANUFACTURING / ORIGINES  
Made in Europe  
Metal parts : Lithuania

DIMENSIONS

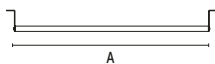

(A) Length / Longueur : 70cm / 27.6in

SPECIFICATIONS / SPÉCIFICITÉS

Flat pack / Livraison à plat  
Maximum load / Charge maximale : 15kg / 33lbs

ECO IMPACT SCORE

Not rated yet / Non évalué à date

Extension leg  
Réhausseur

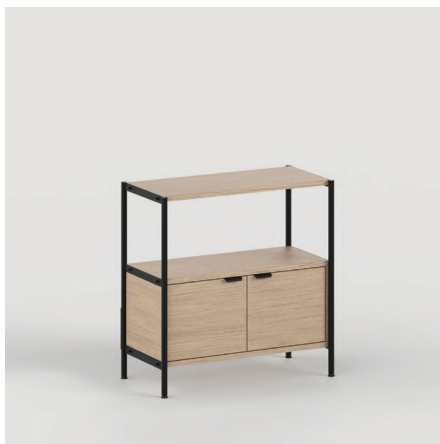

MATERIALS / MATÉRIAUX  
Steel / Acier

MANUFACTURING / ORIGINES  
Made in Europe  
Metal parts : Lithuania

DIMENSIONS

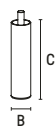

Available for UNIT 01 & 02 / Disponible pour UNIT 01 & 02  
(B) Width / Largeur : 2,5cm / 1in  
(C) Height / Hauteur : 10cm / 3.9in

SPECIFICATIONS / SPÉCIFICITÉS

Flat pack / Livraison à plat

ECO IMPACT SCORE

Not rated yet / Non évalué à date

UNIT STEEL SYSTEM COLLECTION  
by Tiptoe studio

UNIT 01

UNIT 02

North America use rating

|             |   |
|-------------|---|
| RESIDENTIAL | • |
| CONTRACT    | • |

| FRAME<br>STRUCTURE              | SHELF<br>ÉTAGÈRE | Steel / Acier |
|---------------------------------|------------------|---------------|
| Graphite black<br>Noir graphite | ●                | •             |
| Cream white<br>Blanc crème      | ○                | •             |
| Pale blue<br>Bleu pâle          | ●                | •             |



MATERIALS / MATÉRIAUX  
Steel / Acier

MANUFACTURING / ORIGINES  
Made in Europe  
Metal parts : Lithuania



MATERIALS / MATÉRIAUX  
Steel / Acier

MANUFACTURING / ORIGINES  
Made in Europe  
Metal parts : Lithuania

DIMENSIONS

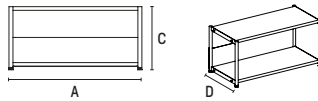

(A) Length / Longueur : 84cm / 33.1in  
(C) Height / Hauteur : 40cm / 15.7in  
(D) Depth / Profondeur : 42cm / 16.5in

SPECIFICATIONS / SPÉCIFICITÉS

Flat pack / Livraison à plat  
Maximum load / Charge maximale : 30kg / 66lbs  
Adjustable foot / Vérins réglables : 1cm / 0.4in

ECO IMPACT SCORE



DIMENSIONS

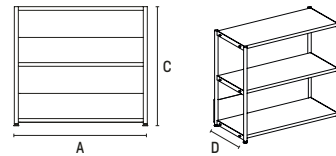

(A) Length / Longueur : 84cm / 33.1in  
(C) Height / Hauteur : 75cm / 29.5in  
(D) Depth / Profondeur : 42cm / 16.5in

SPECIFICATIONS / SPÉCIFICITÉS

Flat pack / Livraison à plat  
Maximum load / Charge maximale : 30kg / 66lbs  
Adjustable foot / Vérins réglables : 1cm / 0.4in

ECO IMPACT SCORE



UNIT 03



MATERIALS / MATÉRIAUX  
Steel / Acier

MANUFACTURING / ORIGINES  
Made in Europe  
Metal parts : Lithuania

DIMENSIONS

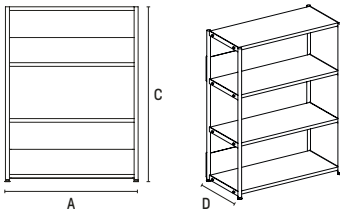

(A) Length / Longueur : 84cm / 33.1in  
(C) Height / Hauteur : 110cm / 43.3in  
(D) Depth / Profondeur : 42cm / 16.5in

SPECIFICATIONS / SPÉCIFICITÉS

Flat pack / Livraison à plat  
Maximum load / Charge maximale : 30kg / 66lbs  
Adjustable foot / Vérins réglables : 1cm / 0.4in

ECO IMPACT SCORE



UNIT 05



MATERIALS / MATÉRIAUX  
Steel / Acier

MANUFACTURING / ORIGINES  
Made in Europe  
Metal parts : Lithuania

DIMENSIONS

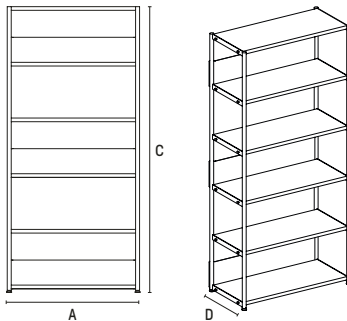

(A) Length / Longueur : 84cm / 33.1in  
(C) Height / Hauteur : 180cm / 70.9in  
(D) Depth / Profondeur : 42cm / 16.5in

SPECIFICATIONS / SPÉCIFICITÉS

Flat pack / Livraison à plat  
Maximum load / Charge maximale : 30kg / 66lbs  
Adjustable foot / Vérins réglables : 1cm / 0.4in

ECO IMPACT SCORE



UNIT 06



MATERIALS / MATÉRIAUX  
Steel / Acier

MANUFACTURING / ORIGINES  
Made in Europe  
Metal parts : Lithuania

DIMENSIONS

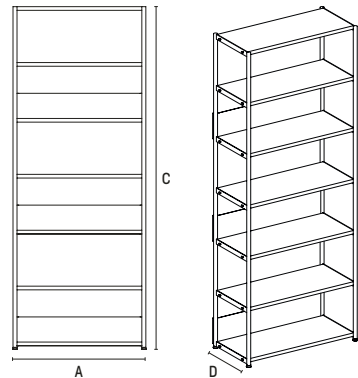

(A) Length / Longueur : 84cm / 33.1in  
(C) Height / Hauteur : 215cm / 84.6in  
(D) Depth / Profondeur : 42cm / 16.5in

SPECIFICATIONS / SPÉCIFICITÉS

Flat pack / Livraison à plat  
Maximum load / Charge maximale : 30kg / 66lbs  
Adjustable foot / Vérins réglables : 1cm / 0.4in

ECO IMPACT SCORE



**Work shelf**  
Tablette de bureau



**MATERIALS / MATÉRIAUX**  
Steel / Acier

**MANUFACTURING / ORIGINES**  
Made in Europe  
Metal parts : Lithuania

**DIMENSIONS**

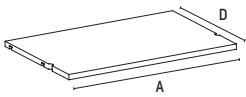

(A) Length / Longueur : 80cm / 31.5in  
(D) Depth / Profondeur : 51cm / 20.1in  
Tabletop thickness / Épaisseur plateau : 2,3cm / 0.8in

**SPECIFICATIONS / SPÉCIFICITÉS**  
Flat pack / Livraison à plat  
Maximum load / Charge maximale : 30kg / 66lbs

**ECO IMPACT SCORE**



**Cabinet doors**  
Bloc porte



**MATERIALS / MATÉRIAUX**  
Steel / Acier

**MANUFACTURING / ORIGINES**  
Made in Europe  
Metal parts : Lithuania

**DIMENSIONS**

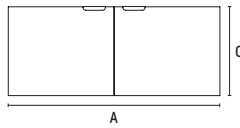

(A) Length / Longueur : 80cm / 31.5in  
(B) Width / Largeur : 35cm / 13.8in  
(C) Height / Hauteur : 37cm / 14.6in

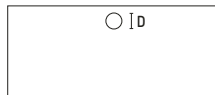

Cable hole for cabinet doors / Passe câble pour le bloc porte  
(D) Diameter / Diamètre : ø5cm / ø2in

**SPECIFICATIONS / SPÉCIFICITÉS**  
Flat pack / Livraison à plat

**ECO IMPACT SCORE**

Not rated yet / Non évalué à date

**Extension leg**  
Réhausseur



**MATERIALS / MATÉRIAUX**  
Steel / Acier

**MANUFACTURING / ORIGINES**  
Made in Europe  
Metal parts : Lithuania

**DIMENSIONS**



Available for UNIT 01 & 02 / Disponible pour UNIT 01 & 02  
(B) Width / Largeur : 2,5cm / 1in  
(C) Height / Hauteur : 10cm / 3.9in

**SPECIFICATIONS / SPÉCIFICITÉS**  
Flat pack / Livraison à plat

**ECO IMPACT SCORE**

Not rated yet / Non évalué à date

# UNIT system safety instructions

## Règles de sécurité pour le système UNIT

### General safety principles

#### Règles de sécurité générales

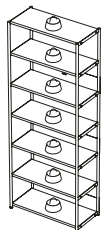

Max weight : 66lbs per shelf  
Poids max : 30kg par étagère



Do not climb  
Ne pas escalader



Assembly : 2 people minimum  
Assemblage : 2 personnes minimum

### UNIT system wall and ground mounting

#### Ancrage murale et au sol pour le système UNIT

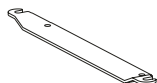
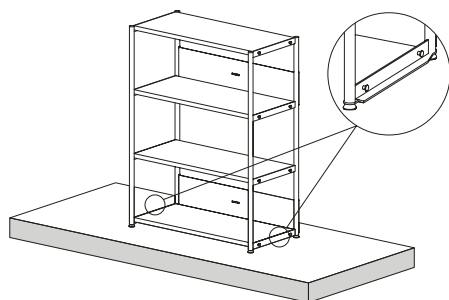

UNIT ground mount  
Accroche au sol UNIT

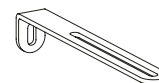
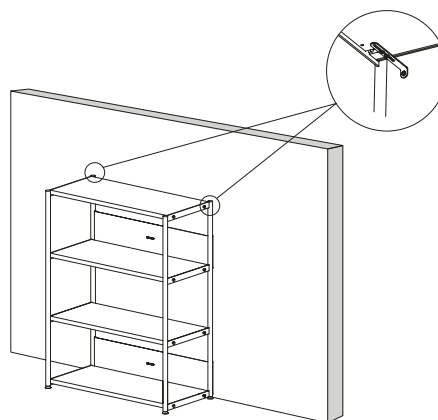

UNIT wall mount  
Accroche murale UNIT

UNIT 3 to 6 in freestanding configurations must be securely anchored to the floor.

Les UNIT 3 à 6 en version autoportante doivent impérativement être fixées au sol.

UNIT 3 to 6 installed against a wall must be securely mounted to the wall.

Les UNIT 3 à 6 installées contre un mur doivent impérativement être fixées au mur.



In all the cases below, UNIT shelves must always be securely mounted to the wall or to the ground.

Dans les situations ci-dessous, les étagères UNIT doivent impérativement être fixées au mur ou au sol.

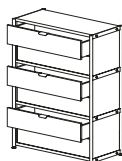

UNIT with drawers  
UNIT avec tiroirs

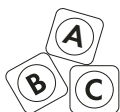

Environments with children  
Environnements avec enfants

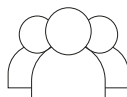

Public spaces  
Espaces publics

## SELECTED CONFIGURATIONS

Low shelving  
Étagère basse

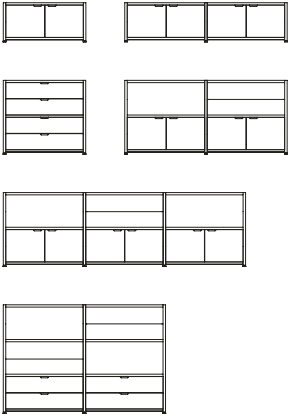

## SELECTED CONFIGURATIONS

Office  
Bureau

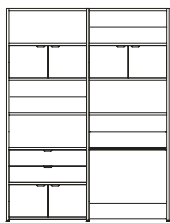
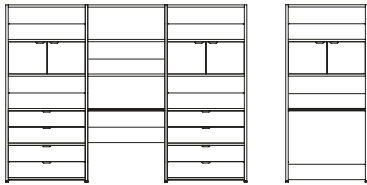
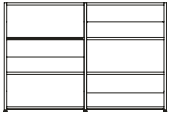

## SELECTED CONFIGURATIONS

High shelving  
Étagère haute

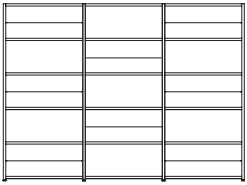
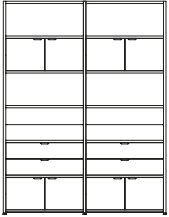
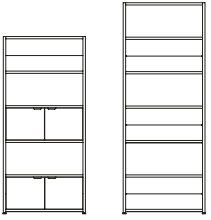



## EASY COLLECTION

BESPOKE OPTIONS AVAILABLE  
SUR-MESURE DISPONIBLE 



2 seater



3/4 seater



Ottoman

## BRIDGE COLLECTION\*

BESPOKE OPTIONS AVAILABLE  
SUR-MESURE DISPONIBLE 



Corner seat\*



Center seat\*



Ottoman\*



Selected configurations





# SOFA CANAPÉ



**EASY COLLECTION**  
by Big-Game

**2 seater**  
2 places

**3/4 seater**  
3/4 places

North America use rating

|             |   |
|-------------|---|
| RESIDENTIAL | • |
| CONTRACT    | • |

| FABRIC<br>TISSU            |   | 2 seater<br>2 places | 3/4 seater<br>3/4 places | Ottoman |
|----------------------------|---|----------------------|--------------------------|---------|
| Slate grey<br>Gris ardoise | ● | •                    | •                        | •       |
| Sand beige<br>Beige sable  | ● | •                    | •                        | •       |
| Midnight blue<br>Bleu nuit | ● | •                    | •                        | •       |
| Forest green<br>Vert forêt | ● | •                    | •                        | •       |
| Heather grey<br>Gris chiné | ● | •                    | •                        | •       |
| Vintage pink<br>Rose chiné | ● | •                    | •                        | •       |



**MATERIALS / MATÉRIAUX**  
Virgin PU foam 35kg/m3 (seat) /  
Mousse vierge PU 35kg/m3 (assise)  
Rec. HR PU flake (cushion) / Flocon PU HR rec. (coussin)  
Powder-coated steel (frame) / Acier thermolaqué (structure)

**MANUFACTURING / ORIGINES**  
Made in Europe  
Metal parts : Lithuania, France, Bulgaria  
Upholstery : Lithuania  
Foam : France

**MATERIALS / MATÉRIAUX**  
Virgin PU foam 35kg/m3 (seat) /  
Mousse vierge PU 35kg/m3 (assise)  
Rec. HR PU flake (cushion) / Flocon PU HR rec. (coussin)  
Powder-coated steel (frame) / Acier thermolaqué (structure)

**MANUFACTURING / ORIGINES**  
Made in Europe  
Metal parts : Lithuania, France, Bulgaria  
Upholstery : Lithuania  
Foam : France

**DIMENSIONS**

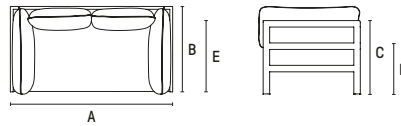

(A) Length / Longueur : 170cm / 66.9in  
(B) Width / Largeur : 90cm / 35.4in  
(C) Height / Hauteur : 88cm / 34.6in  
(D) Seat height / Hauteur d'assise : 40cm / 15.7in  
(E) Seat depth / Profondeur d'assise : 65cm / 25.6in

**DIMENSIONS**

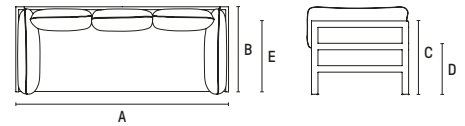

(A) Length / Longueur : 225cm / 88.6in  
(B) Width / Largeur : 90cm / 35.4in  
(C) Height / Hauteur : 88cm / 34.6in  
(D) Seat height / Hauteur d'assise : 40cm / 15.7in  
(E) Seat depth / Profondeur d'assise : 65cm / 25.6in

**SPECIFICATIONS / SPÉCIFICITÉS**  
Flat pack / Livraison à plat  
Removable / Déhoussable

**SPECIFICATIONS / SPÉCIFICITÉS**  
Flat pack / Livraison à plat  
Removable / Déhoussable

**ECO IMPACT SCORE**



**ECO IMPACT SCORE**



## Ottoman

## Gabriel fabric Tissu Gabriel

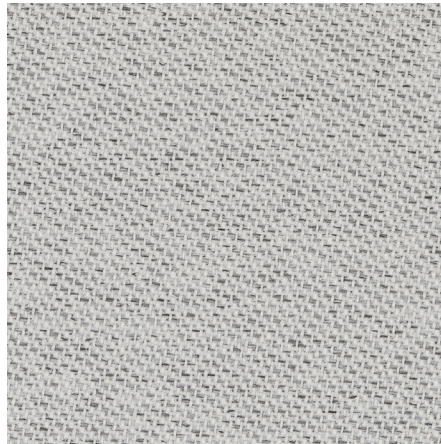

### MATERIALS / MATÉRIAUX

Virgin PU foam 35kg/m<sup>3</sup> (seat) /  
Mousse vierge PU 35kg/m<sup>3</sup> (assise)  
Rec. HR PU flake (cushion) / Flocon PU HR rec. (coussin)  
Powder-coated steel (frame) / Acier thermolaqué (structure)

### MANUFACTURING / ORIGINES

Made in Europe  
Metal parts : Lithuania, France, Bulgaria  
Upholstery : Lithuania  
Foam : France

### DIMENSIONS

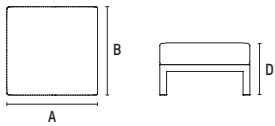

(A) Length / Longueur : 83cm / 32.7in  
(B) Width / Largeur : 80cm / 31.5in  
(D) Seat height / Hauteur d'assise : 40cm / 15.7in

### CHILI & CURA FABRIC RANGE / GAMME DE TISSU CHILI & CURA

Heather grey / Gris chiné : CHILI 60114  
Vintage pink / Rose chiné : CHILI 63092  
Slate grey / Gris ardoise : CURA 60019  
Forest green / Vert forêt : CURA 68182  
Midnight blue / Bleu nuit : CURA 66165  
Sand beige / Beige sable : CURA 61168

### COMPOSITION

100% Post-consumer recycled polyester  
100 % polyester recyclé post-consommation

### PILLING / BOULOCHAGE

4-5 (EN ISO 12945-2)

### RESISTANCE TO ABRASION AND FRICTION /

RÉSISTANCE ABRASION ET FROTTEMENTS

60 000 Martindales (EN ISO 12947-2)

4-5/4-5 (EN ISO 105x12)

Heather grey / Gris chiné

Vintage pink / Rose chiné

100 000 Martindales (ASTM D4157)

4-5/4-5 (EN ISO 105x12)

Slate grey / Gris ardoise

Forest green / Vert forêt

Midnight blue / Bleu nuit

Sand beige / Beige sable

### FIREPROOF STANDARDS / NORMES ANTI-FEU

Non-flammable and flame retardant fabrics depending on

the color, classified M1 (CHILI)

Tissus non inflammables et difficilement inflammables

selon les coloris, classés M1 (CHILI)

### CERTIFICATES

EU Ecolabel Certified Fabrics

OEKO-TEX® STANDARD 100

### SPECIFICATIONS / SPÉCIFICITÉS

Flat pack / Livraison à plat

Removable / Déhoussable

### ECO IMPACT SCORE



**BRIDGE COLLECTION**  
by Tiptoe studio

**Corner seat\***  
Module d'angle

**Center seat\***  
Module central

North America use rating

|             |   |
|-------------|---|
| RESIDENTIAL | • |
| CONTRACT    | • |

| FABRIC<br>TISSU              | Corner seat<br>Module d'angle | Center seat<br>Module central | Ottoman |
|------------------------------|-------------------------------|-------------------------------|---------|
| Slate grey<br>Gris ardoise   | ●                             | •                             | •       |
| Ice grey<br>Gris glacier     | ●                             | •                             | •       |
| Ivory beige<br>Beige ivoire  | ●                             | •                             | •       |
| Ink blue<br>Bleu encre       | ●                             | •                             | •       |
| Snow white<br>Blanc neige    | ●                             | •                             | •       |
| Forest green<br>Vert forêt   | ●                             | •                             | •       |
| Lemon yellow<br>Jaune citron | ●                             | •                             | •       |

\*Made to order



**MATERIALS / MATÉRIAUX**  
HDF wood / Bois HDF  
PU foam HR (seat) / Mousse PU HR (assise)  
Silicone fiber (cushion) / Fibre de silicone (coussin)  
Solid beech (frame) / Hêtre massif (structure)

**MANUFACTURING / ORIGINES**  
Made in Europe  
France, Germany

\*Made to order



**MATERIALS / MATÉRIAUX**  
HDF wood / Bois HDF  
PU foam HR (seat) / Mousse PU HR (assise)  
Silicone fiber (cushion) / Fibre de silicone (coussin)  
Solid beech (frame) / Hêtre massif (structure)

**MANUFACTURING / ORIGINES**  
Made in Europe  
France, Germany

**DIMENSIONS**

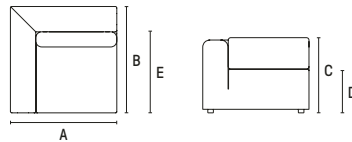

(A) Length / Longueur : 105cm / 41.3in  
(B) Width / Largeur : 105cm / 41.3in  
(C) Height / Hauteur : 72cm / 28.3in  
(D) Seat height / Hauteur d'assise : 43cm / 16.9in  
(E) Seat depth / Profondeur d'assise : 60cm / 23.6in

**SPECIFICATIONS / SPÉCIFICITÉS**  
Not flat pack / Non livré à plat  
Removable / Déhoussable

**ECO IMPACT SCORE**



**DIMENSIONS**

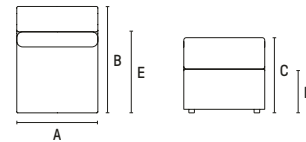

(A) Length / Longueur : 105cm / 41.3in  
(B) Width / Largeur : 80cm / 31.5in  
(C) Height / Hauteur : 72cm / 28.3in  
(D) Seat height / Hauteur d'assise : 43cm / 16.9in  
(E) Seat depth / Profondeur d'assise : 60cm / 23.6in

**SPECIFICATIONS / SPÉCIFICITÉS**  
Not flat pack / Non livré à plat  
Removable / Déhoussable

**ECO IMPACT SCORE**



## Ottoman\*

## Rohi fabric Tissu Rohi



### MATERIALS / MATÉRIAUX

HDF wood / Bois HDF  
PU foam HR (seat) / Mousse PU HR (assise)  
Silicone fiber (cushion) / Fibre de silicone (coussin)  
Solid beech (frame) / Hêtre massif (structure)

### MANUFACTURING / ORIGINES

Made in Europe  
France, Germany

### ARCO FABRIC RANGE / GAMME DE TISSU ARCO

Snow white / Blanc neige : ARCO Snow  
Slate grey / Gris ardoise : ARCO Lanoso  
Ice grey / Gris glacier : ARCO Ice  
Ivory beige / Beige ivoire : ARCO Arctic  
Ink blue / Bleu encre : ARCO Ink  
Fir green / Vert sapin : ARCO Forest  
Lemon yellow / Jaune citron : ARCO Citron

### COMPOSITION

95% virgin wool and 5% polyamide  
95% laine vierge et 5% polyamide

### PILLING / BOULOCHAGE

4-5 (EN ISO 12945-2)

### RESISTANCE TO ABRASION AND FRICTION /

RÉSISTANCE ABRASION ET FROTTEMENTS  
70 000 Martindales (ISO 12947-2)

### FIREPROOF STANDARDS / NORMES ANTI-FEU

On-flammable and flame retardant fabrics, classified M2  
Tissus non inflammables et difficilement inflammables, classés M2

### DIMENSIONS

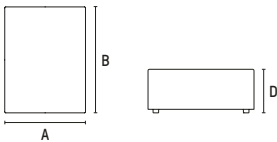

(A) Length / Longueur : 105cm / 41.3in

(B) Width / Largeur : 80cm / 31.5in

(D) Seat height / Hauteur d'assise : 43cm / 16.9in

### SPECIFICATIONS / SPÉCIFICITÉS

Not flat pack / Non livré à plat  
Removable / Déhoussable

### ECO IMPACT SCORE



## SELECTED CONFIGURATIONS

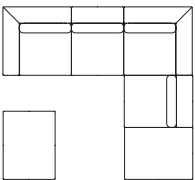
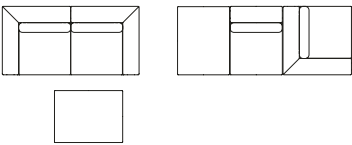
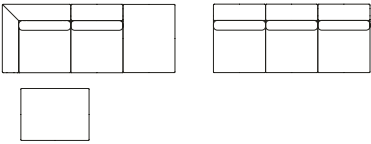
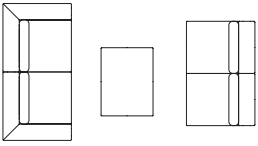
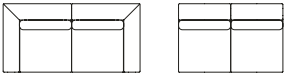



## KIDS COLLECTION\*

---



Table leg\*  
50cm / 19.7in



Desk\*



Stool\*

\*Product not available for the US market

# CHILDREN FURNITURE MOBILIER ENFANT



KIDS COLLECTION  
by Tiptoe studio

Tiptoe table leg - 50cm / 19.7in\*  
Pied de table Tiptoe - 50cm

Kids desk\*  
Bureau Kids

North America use rating

RESIDENTIAL

| TABLE LEG<br>PIED DE TABLE    | HEIGHT<br>HAUTEUR |   |
|-------------------------------|-------------------|---|
|                               | 50cm / 19.7in     |   |
| Cream white<br>Blanc crème    | ○                 | ● |
| Whale blue<br>Bleu baleine    | ●                 | ● |
| Dino green<br>Vert dino       | ●                 | ● |
| Flamingo pink<br>Rose flamant | ●                 | ● |
| Sun yellow<br>Jaune soleil    | ●                 | ● |

| Desk<br>Bureau                | TABLETOP<br>PLATEAU | Oak / Chêne | Tutti Frutti | Vice Versa |
|-------------------------------|---------------------|-------------|--------------|------------|
|                               |                     | ●           | ○            | ●          |
| Cream white<br>Blanc crème    | ○                   | ●           | ●            | ●          |
| Whale blue<br>Bleu baleine    | ●                   | ●           | ●            | ●          |
| Dino green<br>Vert dino       | ●                   | ●           | ●            | ●          |
| Flamingo pink<br>Rose flamant | ●                   | ●           | ●            | ●          |
| Sun yellow<br>Jaune soleil    | ●                   | ●           | ●            | ●          |

TABLE TOP THICKNESS / ÉPAISSEUR PLATEAU

Oak / Chêne : 2,3cm / 0.9in  
Tutti Frutti rec. plas. / Plas. rec. Tutti Frutti : 2,3cm / 0.9in  
Vice Versa : 2,3cm / 0.9in

| Stool<br>Tabouret             | SEAT<br>ASSISE | Oak / Chêne | Tutti Frutti |
|-------------------------------|----------------|-------------|--------------|
|                               |                | ●           | ○            |
| Cream white<br>Blanc crème    | ○              | ●           | ●            |
| Whale blue<br>Bleu baleine    | ●              | ●           | ●            |
| Dino green<br>Vert dino       | ●              | ●           | ●            |
| Flamingo pink<br>Rose flamant | ●              | ●           | ●            |
| Sun yellow<br>Jaune soleil    | ●              | ●           | ●            |



MATERIALS / MATÉRIAUX  
Steel / Acier

MANUFACTURING / ORIGINES  
Made in Europe  
Metal parts : Bulgaria, France

MATERIALS / MATÉRIAUX  
Steel / Acier

Tabletop options :  
Oak veneered plywood «Oak» / Contreplaqué plaqué chêne «Chêne»  
White laminated plywood (Blackboard) «Vice Versa» / Contreplaqué stratifié blanc (ardoise) «Vice Versa»  
HIPS (High Impact Polystyrene) «Tutti Frutti»

MANUFACTURING / ORIGINES  
Made in Europe  
Metal parts : Bulgaria, France  
Wood : Croatia  
Recycled plastic : UK

DIMENSIONS

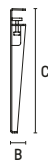

(B) Width / Largeur : 6cm / 2.4in  
(C) Height / Hauteur : 50cm / 19.7in

WEIGHT / POIDS  
1,7kg / 3.74lbs

DIMENSIONS

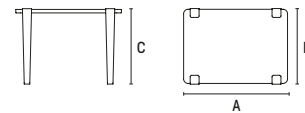

(A) Length / Longueur : 70cm / 27.6in  
(B) Width / Largeur : 50cm / 19.7in  
(C) Height / Hauteur : 50cm / 19.7in

VICE VERSA BLACKBOARD  
White laminated plywood



TUTTI FRUTTI REC. PLAS.  
HIPS (High Impact Polystyrene)



SPECIFICATIONS / SPÉCIFICITÉS  
Flat pack / Livraison à plat

SPECIFICATIONS / SPÉCIFICITÉS  
Flat pack / Livraison à plat  
Maximum load / Charge maximale : 70kg / 154.3lbs

ECO IMPACT SCORE



ECO IMPACT SCORE



## Mini-Lou stool\*

Tabouret Mini-Lou



### MATERIALS / MATÉRIAUX

Steel / Acier

Solid oak «Oak» / Chêne massif «Chêne»

HIPS (High Impact Polystyrene) «Tutti Frutti»

### MANUFACTURING / ORIGINES

Made in Europe

Metal parts : Bulgaria, France

Wood : Czech Republic

Recycled plastic : UK

### DIMENSIONS

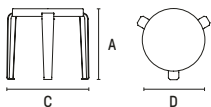

(A) Height / Hauteur : 30cm / 11.8in

(C) Floor space / Emprise au sol : 35x30cm / 13.8x11.8in

(D) Seat diameter / Diamètre d'assise : ø30cm / ø11.8in

### SPECIFICATIONS / SPÉCIFICITÉS

Flat pack / Livraison à plat

Stackable / Empilable : 7

### ECO IMPACT SCORE



## MIDI COLLECTION

BESPOKE OPTIONS AVAILABLE  
SUR-MESURE DISPONIBLE 



Outdoor table leg  
75cm / 29.5in



Dining table



SSDr outdoor chair

## PANORAMA COLLECTION

BESPOKE OPTIONS AVAILABLE  
SUR-MESURE DISPONIBLE 



Dining table



Coffee table



Chair



Armchair



Lounge armchair



Bench



Stool

## MOKA COLLECTION

BESPOKE OPTIONS AVAILABLE  
SUR-MESURE DISPONIBLE 



Bistro table



Bistro table



**OUTDOOR FURNITURE**  
**MOBILIER EXTÉRIEUR**



**MIDI COLLECTION**  
by Tiptoe studio

North America use rating

|             |   |
|-------------|---|
| RESIDENTIAL | • |
| CONTRACT    | • |

|                                 | Table leg<br>Pied de table | Table | SSDr chair<br>Chaise SSDr |
|---------------------------------|----------------------------|-------|---------------------------|
| Graphite black<br>Noir graphite | ●                          | •     | •                         |
| Chalk grey<br>Gris craie        | ●                          | •     | •                         |
| Fir green<br>Vert forêt         | ●                          | •     | •                         |
| Brick red<br>Rouge brique       | ●                          | •     | •                         |
| Sun yellow<br>Jaune soleil      | ●                          | •     | •                         |

**Outdoor table legs**  
Pied de table extérieur



**MATERIALS / MATÉRIAUX**  
Powder-coated steel with cataphoresis anti-corrosion treatment / Acier thermolaqué avec traitement anti-corrosion par cataphorèse

**MANUFACTURING / ORIGINES**  
Made in Europe  
Metal parts : Lithuania

**Outdoor dining table**  
Table à manger d'extérieur



**MATERIALS / MATÉRIAUX**  
Powder-coated steel with cataphoresis anti-corrosion treatment / Acier thermolaqué avec traitement anti-corrosion par cataphorèse

**MANUFACTURING / ORIGINES**  
Made in Europe  
Metal parts : Lithuania

**DIMENSIONS**



(B) Width / Largeur : 6cm / 2.4in  
(C) Height / Hauteur : 75cm / 29.5in

**WEIGHT / POIDS**  
2,5kg / 5.5lbs

**SPECIFICATIONS / SPÉCIFICITÉS**  
Flat pack / Livraison à plat

**ECO IMPACT SCORE**  
Not rated yet / Non évalué à date

**DIMENSIONS**

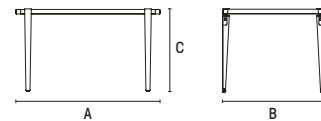

(A) Length / Longueur : 130cm / 51.2in  
(B) Width / Largeur : 80cm / 31.5in  
(C) Height / Hauteur : 75cm / 29.5in

(A) Length / Longueur : 160cm / 63in  
(B) Width / Largeur : 80cm / 31.5in  
(C) Height / Hauteur : 75cm / 29.5in

(A) Length / Longueur : 190cm / 74.8in  
(B) Width / Largeur : 80cm / 31.5in  
(C) Height / Hauteur : 75cm / 29.5in

**SPECIFICATIONS / SPÉCIFICITÉS**  
Flat pack / Livraison à plat  
Maximum load / Charge maximale : 70kg / 154.3lbs  
Adjustable foot / Vérins réglables : 1cm / 0.4in

**ECO IMPACT SCORE**



SSDr outdoor chair  
Chaise d'extérieur SSDr



**MATERIALS / MATÉRIAUX**

Recycled plastic / Plastique recyclé

Powder-coated steel with cathoresis anti-corrosion  
treatment / Acier thermolaqué avec traitement anti-  
corrosion par cataphorèse

**MANUFACTURING / ORIGINES**

Made in Europe

Metal parts : Lithuania, France

Recycled plastic : France

**DIMENSIONS**

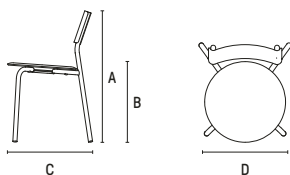

(A) Height / Hauteur : 82cm / 32.3in

(B) Seat height / Hauteur d'assise : 48cm / 18.9in

(C) Floor space / Emprise au sol : 48x54cm / 18.9x21.3in

(D) Seat diameter / Diamètre d'assise : ø40cm / ø15.7in

**SPECIFICATIONS / SPÉCIFICITÉS**

Flat pack / Livraison à plat

Max user load / Poids max utilisateur : 120kg / 264,61bs

Stackable / Empilable : 6

**ECO IMPACT SCORE**



PANORAMA COLLECTION  
by Tiptoe studio

North America use rating

|             |   |
|-------------|---|
| RESIDENTIAL | • |
| CONTRACT    | • |

|                                 | Table | Coffee Table<br>Table basse | Chair / Chaise | Armchair<br>Chaise accoudoirs | Lounge chair<br>Chaise lounge |
|---------------------------------|-------|-----------------------------|----------------|-------------------------------|-------------------------------|
| Graphite black<br>Noir graphite | ●     | •                           | •              | •                             | •                             |
| Chalk grey<br>Gris craie        | ●     | •                           | •              | •                             | •                             |
| Fir green<br>Vert forêt         | ●     | •                           | •              | •                             | •                             |
| Brick red<br>Rouge brique       | ●     | •                           | •              | •                             | •                             |
| Sun yellow<br>Jaune soleil      | ●     | •                           | •              | •                             | •                             |

Outdoor dining table  
Table à manger d'extérieur



**MATERIALS / MATÉRIAUX**  
Powder-coated steel with cataphoresis anti-corrosion treatment / Acier thermolaqué avec traitement anti-corrosion par cataphorèse

**MANUFACTURING / ORIGINES**  
Made in Europe  
Metal parts : Lithuania

DIMENSIONS

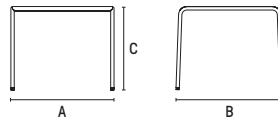

(A) Length / Longueur : 90cm / 35.4in  
(B) Width / Largeur : 90cm / 35.4in  
(C) Height / Hauteur : 71cm / 28in

(A) Length / Longueur : 130cm / 51.2in  
(B) Width / Largeur : 90cm / 35.4in  
(C) Height / Hauteur : 71cm / 28in

(A) Length / Longueur : 160cm / 63in  
(B) Width / Largeur : 90cm / 35.4in  
(C) Height / Hauteur : 71cm / 28in

(A) Length / Longueur : 190cm / 74.8in  
(B) Width / Largeur : 90cm / 35.4in  
(C) Height / Hauteur : 71cm / 28in

SPECIFICATIONS / SPÉCIFICITÉS

Flat pack / Livraison à plat  
Adjustable foot / Vérins réglables : 1cm / 0.4in

ECO IMPACT SCORE



Outdoor coffee table  
Table basse d'extérieur



**MATERIALS / MATÉRIAUX**  
Powder-coated steel with cataphoresis anti-corrosion treatment / Acier thermolaqué avec traitement anti-corrosion par cataphorèse

**MANUFACTURING / ORIGINES**  
Made in Europe  
Metal parts : Lithuania

DIMENSIONS

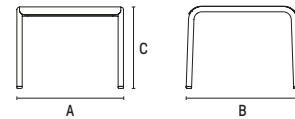

(A) Length / Longueur : 50cm / 19.7in  
(B) Width / Largeur : 50cm / 19.7in  
(C) Height / Hauteur : 38cm / 15in

SPECIFICATIONS / SPÉCIFICITÉS

Flat pack / Livraison à plat  
Not stackable / Non empilable

ECO IMPACT SCORE

Not rated yet / Non évalué à date

**Outdoor chair**  
Chaise d'extérieur



**MATERIALS / MATÉRIAUX**  
Powder-coated steel with cathoporesis anti-corrosion treatment / Acier thermolaqué avec traitement anti-corrosion par cataphorèse

**MANUFACTURING / ORIGINES**  
Made in Europe  
Metal parts : Lithuania

**DIMENSIONS**

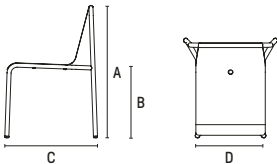

(A) Height / Hauteur : 82cm / 32.3in  
(B) Seat height / Hauteur d'assise : 46cm / 18.1in  
(C) Floor space / Emprise au sol : 47x51cm / 18.5x20.1in  
(D) Seat / Assise : 40x40cm / 15.7x15.7in

**SPECIFICATIONS / SPÉCIFICITÉS**

Not flat pack / Non livré à plat  
Max user load / Poids max utilisateur : 120kg / 264,61bs  
Stackable / Empilable : 4

**ECO IMPACT SCORE**



**Outdoor armchair**  
Chaise accoudoirs d'extérieur



**MATERIALS / MATÉRIAUX**  
Powder-coated steel with cathoporesis anti-corrosion treatment / Acier thermolaqué avec traitement anti-corrosion par cataphorèse

**MANUFACTURING / ORIGINES**  
Made in Europe  
Metal parts : Lithuania

**DIMENSIONS**

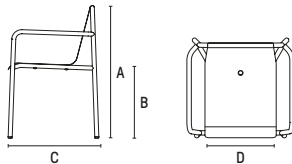

(A) Height / Hauteur : 82cm / 32.3in  
(B) Seat height / Hauteur d'assise : 46cm / 18.1in  
(C) Floor space / Emprise au sol : 47x51cm / 18.5x20.1in  
(D) Seat / Assise : 40x40cm / 15.7x15.7in

**SPECIFICATIONS / SPÉCIFICITÉS**

Not flat pack / Non livré à plat  
Max user load / Poids max utilisateur : 120kg / 264,61bs  
Stackable / Empilable : 4

**ECO IMPACT SCORE**



**Outdoor lounge armchair**  
Chaise lounge accoudoirs d'extérieur



**MATERIALS / MATÉRIAUX**  
Powder-coated steel with cathoporesis anti-corrosion treatment / Acier thermolaqué avec traitement anti-corrosion par cataphorèse

**MANUFACTURING / ORIGINES**  
Made in Europe  
Metal parts : Lithuania

**DIMENSIONS**

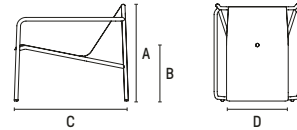

(A) Height / Hauteur : 68cm / 26.8in  
(B) Seat height / Hauteur d'assise : 30,5cm / 12in  
(C) Floor space / Emprise au sol : 67x78cm / 26.4x30.7in  
(D) Seat / Assise : 49.2x40cm / 19.4x15.7in

**SPECIFICATIONS / SPÉCIFICITÉS**

Not flat pack / Non livré à plat  
Max user load / Poids max utilisateur : 120kg / 264,61bs  
Not stackable / Non empilable

**ECO IMPACT SCORE**

Not rated yet / Non évalué à date

PANORAMA COLLECTION  
by Tiptoe studio

North America use rating

|             |   |
|-------------|---|
| RESIDENTIAL | • |
| CONTRACT    | • |

|                                 |   | Bench / Banc | Stool / Tabouret |
|---------------------------------|---|--------------|------------------|
| Graphite black<br>Noir graphite | ● | •            | •                |
| Chalk grey<br>Gris craie        | ● | •            | •                |
| Fir green<br>Vert forêt         | ● | •            | •                |
| Brick red<br>Rouge brique       | ● | •            | •                |
| Sun yellow<br>Jaune soleil      | ● | •            | •                |

Outdoor bench  
Banc d'extérieur



**MATERIALS / MATÉRIAUX**  
Powder-coated steel with cataphoresis anti-corrosion treatment / Acier thermolaqué avec traitement anti-corrosion par cataphorèse

**MANUFACTURING / ORIGINES**  
Made in Europe  
Metal parts : Lithuania

DIMENSIONS

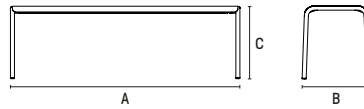

(A) Length / Longueur : 140cm / 55.1in  
(B) Width / Largeur : 40cm / 15.7in  
(C) Height / Hauteur : 45cm / 17.7in

(A) Length / Longueur : 170cm / 66.9in  
(B) Width / Largeur : 40cm / 15.7in  
(C) Height / Hauteur : 45cm / 17.7in

SPECIFICATIONS / SPÉCIFICITÉS

Flat pack / Livraison à plat  
Max user load / Poids max utilisateur : 120kg / 264,61bs  
Not stackable / Non empilable

ECO IMPACT SCORE

Not rated yet / Non évalué à date

Outdoor stool  
Tabouret d'extérieur



**MATERIALS / MATÉRIAUX**  
Powder-coated steel with cataphoresis anti-corrosion treatment / Acier thermolaqué avec traitement anti-corrosion par cataphorèse

**MANUFACTURING / ORIGINES**  
Made in Europe  
Metal parts : Lithuania

DIMENSIONS

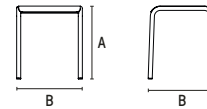

(A) Height / Hauteur : 45cm / 17.7in  
(B) Width / Largeur : 41x41cm / 16.1x16.1in

SPECIFICATIONS / SPÉCIFICITÉS

Not flat pack / Non livré à plat  
Max user load / Poids max utilisateur : 120kg / 264,61bs  
Not stackable / Non empilable

ECO IMPACT SCORE

Not rated yet / Non évalué à date



**MOKA COLLECTION**  
by Tiptoe studio

**Outdoor bistro table**  
Table bistro d'extérieur

North America use rating

|             |   |
|-------------|---|
| RESIDENTIAL | • |
| CONTRACT    | • |

|                                 |   |                 |                       |
|---------------------------------|---|-----------------|-----------------------|
|                                 |   | ø70cm / ø27.6in | 70x70cm / 27.6x27.6in |
| Graphite black<br>Noir graphite | ● | •               | •                     |
| Chalk grey<br>Gris craie        | ● | •               | •                     |
| Fir green<br>Vert forêt         | ● | •               | •                     |
| Brick red<br>Rouge brique       | ● | •               | •                     |
| Sun yellow<br>Jaune soleil      | ● | •               | •                     |



**MATERIALS / MATÉRIAUX**  
Powder-coated steel with cataphoresis anti-corrosion treatment / Acier thermolaqué avec traitement anti-corrosion par cataphorèse

**MANUFACTURING / ORIGINES**  
Made in Europe  
Metal parts : Lithuania



**MATERIALS / MATÉRIAUX**  
Powder-coated steel with cataphoresis anti-corrosion treatment / Acier thermolaqué avec traitement anti-corrosion par cataphorèse

**MANUFACTURING / ORIGINES**  
Made in Europe  
Metal parts : Lithuania

**DIMENSIONS**

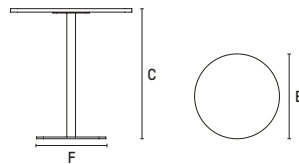

(C) Height / Hauteur : 75cm / 29.5in  
(E) Diameter / Diamètre : ø70cm / ø27.6in  
(F) Base / Socle : ø40cm / ø15.7in

**SPECIFICATIONS / SPÉCIFICITÉS**

Not flat pack / Non livré à plat  
Adjustable foot / Vérins réglables : 1cm / 0.4in

**ECO IMPACT SCORE**



**DIMENSIONS**

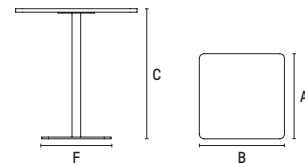

(A) Length / Longueur : 70cm / 27.6in  
(B) Width / Largeur : 70cm / 27.6in  
(C) Height / Hauteur : 75cm / 29.5in  
(F) Base / Socle : 40x40cm / 15.7x15.7in

**SPECIFICATIONS / SPÉCIFICITÉS**

Not flat pack / Non livré à plat  
Adjustable foot / Vérins réglables : 1cm / 0.4in

**ECO IMPACT SCORE**





NOD COLLECTION\*

---

\*Product not available for the US market



Table lamp\*

# LIGHTING LUMINAIRE



**NOD COLLECTION**  
by Tiptoe studio

**Table lamp\***  
Lampe à poser

**Light**  
Lumière

North America use rating

|             |   |
|-------------|---|
| RESIDENTIAL | • |
| CONTRACT    | • |

|                                    | Table lamp<br>Lampe à poser |
|------------------------------------|-----------------------------|
| Graphite black<br>Noir graphite    | ● •                         |
| Cream white<br>Blanc crème         | ○ •                         |
| Eucalyptus grey<br>Gris eucalyptus | ● •                         |
| Royal blue<br>Bleu roi             | ● •                         |
| Naples yellow<br>Jaune de Naples   | ● •                         |



**MATERIALS / MATÉRIAUX**  
Aluminium  
Steel / Acier  
Plastic / Plastique  
Rubber / Caoutchouc

**MANUFACTURING / ORIGINES**  
France  
Portugal  
Non-EU electronic components /  
Composants électroniques hors UE

**LIGHT INTENSITY / INTENSITÉ LUMINEUSE**  
Max 264 lm

**LIGHT TEMPERATURE / TEMPÉRATURE LUMINEUSE**  
3000k neutral white / 3000k blanc neutre

**POWER / PUISSANCE**  
3W

**VOLTAGE**  
100-240V

The lamp features an adjustable dimmer /  
La lampe est équipée d'un régulateur d'intensité variable

**DIMENSIONS**

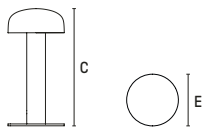

(C) Height / Hauteur : 25cm / 9.8in  
(E) Diameter / Diamètre : 12cm / 4.7in

**SPECIFICATIONS / SPÉCIFICITÉS**  
Not flat pack / Non livré à plat

**ECO IMPACT SCORE**  
Not rated yet / Non évalué à date





The selection of materials is defined at the product design stage. It determines the mechanical strength of the components, their expected service life, and their ability to be recycled at end of life. Materials are selected for their robustness, availability, and compatibility with existing recycling streams.

Le choix des matériaux intervient dès la conception des produits. Il conditionne la résistance mécanique des pièces, leur durée d'usage et leur capacité à être recyclées en fin de vie. Les matériaux sélectionnés sont choisis pour leur robustesse, leur disponibilité et leur compatibilité avec des filières de recyclage existantes.

## Steel & aluminium

### Acier & aluminium

Steel and aluminium are selected for their mechanical properties, long-term stability, and fire resistance (non-combustible materials). These metals are fully recyclable and can be reintroduced into a new production cycle without significant loss of their properties. They form the main structural components of several products, ensuring excellent mechanical strength and optimized end-of-life recyclability.

Steel parts are powder-coated to ensure protection and long-term durability. This process consists of applying a polyester-based paint using an electrostatic method, ensuring 100% coverage of the parts and long-lasting protection against UV exposure and weathering. For products intended for outdoor use, the steel undergoes cathodic electrocoating (e-coating) followed by powder coating to provide enhanced corrosion protection. Precision components, including hardware and screws, are manufactured in the family-owned factory of Matthieu Bourgeaux, co-founder of Tiptoe. Located in Haute-Savoie, this factory has partnered with the studio since its creation in 2015 and guarantees a high level of industrial standards, quality control, and traceability.

L'acier et l'aluminium sont utilisés pour leurs propriétés mécaniques, leur stabilité dans le temps et leur résistance au feu (matériaux ininflammables). Ces métaux sont entièrement recyclables et peuvent être réintroduits dans un nouveau cycle de production sans altération significative de leurs propriétés. Ils constituent la structure principale de plusieurs éléments et garantissent une excellente tenue mécanique ainsi qu'une recyclabilité optimisée en fin de vie.

Les pièces en acier bénéficient d'un traitement par thermolaquage pour assurer leur protection et leur durabilité. Ce traitement consiste en l'application d'une peinture polyester, par procédé électrostatique, garantissant une couverture à 100 % des pièces et une protection durable contre les UV et les intempéries. Pour les produits destinés à un usage extérieur, l'acier est traité par cathodisation et thermolaquage pour assurer une protection anti-corrosion. Les pièces de précision, notamment la visserie, sont fabriquées au sein de l'usine familiale de Matthieu Bourgeaux, cofondateur de Tiptoe. Située en Haute-Savoie, cette usine accompagne le studio depuis sa création en 2015 et garantit un haut niveau d'exigence industrielle, de qualité et de traçabilité.

## Recycled plastic

### Plastique recyclé

This material is made from plastic waste that has been re-processed into raw material. Its use helps reduce reliance on virgin plastics while meeting the technical requirements of the relevant components. The material is recyclable at the end of its life. The Venezia, Tutti Frutti and Macchiato materials are made from 100% recycled HIPS (High-Impact Polystyrene). The forming process is semi-artisanal, giving each piece a unique and slightly heterogeneous appearance. The Venezia material is produced from recycled plastic sourced from yogurt pots. The material is obtained through the collection, grinding and pressing of plastic waste, without the addition of resin or binding agents. The recycled polypropylene used for our SSSR chairs incorporates a UV-resistant treatment, ensuring improved material and color stability when exposed to natural light.

Ce matériau est issu de déchets plastiques retransformés en matière première. Son utilisation permet de limiter le recours aux plastiques vierges tout en répondant aux contraintes techniques des pièces concernées. Le matériau est recyclable en fin de vie. Les matériaux Venezia, Tutti Frutti et Macchiato sont 100% HIPS recyclé. Le procédé de mise en forme est semi-artisanal, conférant à chaque pièce un aspect unique et légèrement hétérogène. Le matériau Venezia est fabriqué à partir de plastique recyclé issu de pots de yaourt. La matière est obtenue par collecte, broyage puis pressage des déchets plastiques, sans ajout de résine ni de liant. Le polypropylène recyclé, utilisé pour nos chaises SSSR, intègre un traitement anti-UV, permettant une meilleure tenue du matériau et de la couleur face à l'exposition naturelle lumineuse.

## Wood

### Bois

The wood used (solid wood, plywood, or particleboard) comes from sustainably managed European forests certified FSC or PEFC. These certifications regulate forestry practices, including forest regeneration and the preservation of forest ecosystems. The finishes applied to the wood are predominantly water-based varnishes. All of our veneers are made from real wood (oak or walnut). The majority of our table tops incorporate a solid oak frame on all sides to ensure strength and durability. The so-called "old oak" table tops are made from solid oak. They are subject to a specific selection process at the time of cutting: each piece is chosen for its natural texture, tonal variations, and pronounced knots.

Le bois utilisé (massif, contreplaqué ou aggloméré) provient de forêts européennes gérées durablement et certifiées FSC ou PEFC. Ces certifications encadrent les pratiques d'exploitation forestière, notamment le renouvellement des peuplements et la préservation des écosystèmes forestiers. Les finitions appliquées sur le bois sont majoritairement des vernis à base d'eau. L'ensemble de nos placages est réalisé en bois massif (chêne ou noyer). La majorité de nos plateaux intègre des alaises en chêne massif sur l'ensemble des côtés pour assurer leurs solidité. Les plateaux dits « bois ancien » sont réalisés en chêne massif. Ils font l'objet d'une sélection spécifique dès la coupe du bois : les pièces sont choisies pour leurs aspérités naturelles, leurs nuances de teinte et la présence de nœuds marqués.

## White laminated plywood Stratifié blanc

Our tabletops featuring a white laminate surface offer excellent resistance to abrasion and impact. The laminate surface is particularly hard and dense, making them perfectly suited for intensive use and collective environments. The edges are finished in a clear lacquer, revealing the industrial character of the plywood core.

Nos plateaux, dotés d'un revêtement stratifié blanc, offrent une excellente résistance à l'abrasion et aux chocs. Leur couche supérieure, particulièrement dure et dense, les rend parfaitement adaptés à un usage intensif et aux environnements collectifs. Les chants sont bruts et laissent apparaître le côté industriel du contreplaqué.

## Fabric Tissu

The Gabriel textiles used across our different product ranges are made from recycled sources or natural fibers. Machine washable, they offer high abrasion resistance, making them perfectly suited for intensive use, as well as good fire resistance in compliance with M1 to M2 standards. Only our sofa covers are removable for machine washing. Our chairs and stools use fixed upholstery to ensure long term durability. The textiles can still be washed with a suitable detergent, and the upholstered panel can easily be replaced if required.

Le tissu Gabriel utilisé dans nos différentes gammes de produits provient de filières recyclées ou de fibres naturelles. Lavable en machine, il offre une haute résistance à l'abrasion, parfaitement adapté à un usage intensif, ainsi qu'une bonne résistance au feu, conforme aux normes M1 à M2. Seules les housses de nos canapés sont amovibles et lavables en machine. Nos chaises et tabourets sont dotés d'un revêtement fixe afin de garantir une durabilité à long terme. Les textiles peuvent néanmoins être nettoyés avec un détergent adapté, et le panneau tapissé peut être remplacé facilement si nécessaire.

## Foam Mousse

All seat cushions are made from high-density virgin foam (HR 35 kg/m<sup>3</sup>), ensuring comfort, resilience, and durability over time. For our Easy sofa range, post industrial recycled foam (produced from the grinding of virgin foam offcuts), is used for the padding of backrests and armrests.

Les mousses d'assises sont réalisées en mousse vierge haute densité (HR35 Kg/m<sup>3</sup>) sur l'ensemble de nos assises. Pour notre gamme de canapés Easy, la mousse recyclée, issue du broyage de mousse vierge, est utilisée pour le garnissage de nos dossiers et accoudoirs.

## WARRANTY & USE RATING GARANTIES & USAGE

### Warranty Garanties

The Tiptoe functional warranty covers all issues related to a functional defect in our products, such as mechanical parts, welds, or bending. The following defects are not covered by the functional warranty:

- Surface alterations (stains, marks, discoloration, corrosion not declared at the time of product delivery)
- Damage resulting from failure to follow the use and installation precautions provided by Tiptoe
- Wear and natural aging of surfaces

La garantie fonctionnelle Tiptoe couvre tous les problèmes liés à un défaut fonctionnel de nos produits, tels que les pièces mécaniques, les soudures ou le pliage. Les défauts suivants ne sont pas couverts par la garantie fonctionnelle :

- L'altération des surfaces (tâches, auréoles, décolorations, corrosion non déclarées à la livraison des produits)
- Les détériorations liées au non-respect des précautions d'usage et d'installation fournies par Tiptoe
- L'usure et le vieillissement naturel des surfaces

### Europe

| COLLECTION             | Functional warranty<br>Garantie fonctionnelle | Anti-corrosion warranty<br>Garantie anticorrosion |
|------------------------|---|---|
| Tiptoe / Bracket / Pli | Lifetime<br>À vie                             | x   |
| Indoor collections     | 5 years<br>5 ans                              | x   |
| Outdoor collections    | 5 years<br>5 ans                              | 2 years<br>2 ans                                  |

### North America

| COLLECTION          | Functional warranty | Anti-corrosion warranty |
|---------------------|---------------------|-------------------------|
| Indoor collections  | 2 years             | x                       |
| Outdoor collections | 2 years             | x                       |

### North America use rating

**Residential:** product designed for residential use in non-public indoor spaces and, when applicable, outdoor spaces such as gardens, terraces and balconies.

|             |   |
|-------------|---|
| RESIDENTIAL | • |
|-------------|---|

**Contract:** product designed for professional use in supervised public indoor or outdoor spaces such as restaurants, hotels, offices, pools, beaches, multi-family or rental units, and corporate environments.

|             |   |
|-------------|---|
| RESIDENTIAL | • |
| CONTRACT    | • |

## CERTIFICATES CERTIFICATS

|                                     | Wood / Bois   |
|-------------------------------------|---|
| «Oak» / «Chêne»                     | Oak veneered plywood / Contreplaqué plaqué chêne                                |
| «Oak» / «Chêne»                     | Solid oak / Chêne massif  |
| «Old oak» / «Bois ancien»           | Solid oak / Chêne massif  |
| «Tinted oak» / «Chêne teinté»       | Solid oak / Chêne massif  |
| «Tinted ash» / «Frêne teinté»       | Ash veneered plywood / Contreplaqué plaqué frêne                                |
| «Tinted beech» / «Hêtre teinté»     | Beech veneered plywood / Contreplaqué plaqué hêtre                              |
| «Chroma Edition»                    | Tinted solid beech / Hêtre massif teinté  |
| «Walnut» / «Noyer»                  | Walnut veneered plywood / Contreplaqué plaqué noyer                             |
| «Vice Versa»                        | White laminate plywood (blackboard) /<br>Contreplaqué stratifié blanc (ardoise) |
| «White plywood» / «Stratifié blanc» | White laminate plywood / Contreplaqué stratifié blanc                           |
| «Versailles»                        | Versailles flooring / Parquet Versailles  |



|  | Recycled plastic / Plastique recyclé           |
|--|--|
| «Recycled plastic» / «Plastique recyclé» | Recycled polypropylene / Polypropylène recyclé |
| «Venezia»                                | HIPS*  |
| «Macchiato»                              | HIPS*  |
| «Tutti Frutti»                           | HIPS*  |



\*(High Impact Polystyrene)

### Gabriel fabric / Tissu Gabriel

Slate grey / Gris ardoise : CURA 60019  
 Forest green / Vert forêt : CURA 68182  
 Midnight blue / Bleu nuit : CURA 66165  
 Sand beige / Beige sable : CURA 61168  
 Heather grey / Gris chiné : CHILI 60114  
 Vintage pink / Rose chiné : CHILI 63092  
 Sand beige / Beige sable : CYBER 1101  
 Carbon black / Noir charbon : CYBER 3101  
 Classified M1 (CHILI) / Classés M1 (CHILI)



### Rohi fabric / Tissu Rohi

Snow white / Blanc neige : ARCO Snow  
 Slate grey / Gris ardoise : ARCO Lanoso  
 Ice grey / Gris glacier : ARCO Ice  
 Ivory beige / Beige ivoire : ARCO Arctic  
 Ink blue / Bleu encre : ARCO Ink  
 Fir green / Vert sapin : ARCO Forest  
 Lemon yellow / Jaune citron : ARCO Citron  
 Classified M2 / Classés M2



## CARE GUIDE ENTRETIEN



### Metal / Acier

#### Powder-Coated steel Acier thermolaqué

Clean the surface regularly using a soft cloth or a non-abrasive sponge with lukewarm water and mild soap. Rinse thoroughly with clean water, then dry immediately with a clean, dry cloth to prevent streaks. Never use chemical products, solvents or aggressive cleaners such as alcohol, acetone, gasoline, acids or bleach, as they may damage the paint and finish. Additional tip: Regular maintenance helps prevent build-up and significantly extends the durability of the coating, especially in outdoor or humid environments.

Nettoyez régulièrement la surface à l'aide d'un chiffon doux ou d'une éponge non abrasive imbibée d'eau tiède et de savon doux. Rincez soigneusement à l'eau claire, puis essuyez immédiatement avec un chiffon propre et sec afin d'éviter les traces. N'utilisez jamais de produits chimiques, solvants ou nettoyeurs agressifs tels que l'alcool, l'acétone, l'essence, les acides ou l'eau de Javel, qui risqueraient d'altérer la peinture et la finition. Astuce complémentaire : un entretien régulier permet d'éviter l'encrassement et prolonge significativement la tenue de la peinture, notamment en environnement extérieur ou humide.



#### Brushed stainless steel Inox brossé

Brushed stainless steel is durable and elegant, but requires regular care to maintain its appearance. Clean the surface with a soft, clean cloth slightly dampened with lukewarm water and a mild detergent, then dry immediately with a dry cloth to avoid marks. Avoid abrasive products, solvents, alcohol or rough sponges, which may scratch or dull the metal. To remove fingerprints or limescale, use a soft cloth lightly moistened with vinegar water or a cleaner specifically designed for stainless steel.

L'inox brossé est résistant et élégant, mais il nécessite un entretien régulier pour conserver son aspect. Nettoyez la surface avec un chiffon doux et propre légèrement humidifié avec de l'eau tiède et un détergent doux, puis essuyez immédiatement avec un chiffon sec afin d'éviter les traces. Évitez les produits abrasifs, les solvants, l'alcool ou les éponges rugueuses, qui peuvent rayer ou ternir le métal. Pour éliminer les traces de doigts ou de calcaire, utilisez un chiffon doux légèrement imbibé d'eau vinaigrée ou d'un produit spécialement conçu pour l'inox.

## CARE GUIDE ENTRETIEN



## Recycled plastic / Plastique recyclé

### Recycled plastic Plastique recyclé

Recycled plastics are durable materials made from reclaimed resources. For maintenance, clean the surface with a soft cloth using lukewarm water and a neutral detergent, then dry carefully to avoid marks. Regular care helps preserve both the appearance and durability of the material. It is also recommended to avoid prolonged exposure to direct heat sources, which may damage the surface.

Les plastiques recyclés sont des matériaux résistants issus de matières revalorisées. Pour leur entretien, nettoyez la surface à l'aide d'un chiffon doux avec de l'eau tiède additionnée d'un détergent neutre, puis séchez soigneusement afin d'éviter l'apparition de traces. Un entretien régulier permet de préserver l'aspect et la durabilité du matériau. Il est également conseillé d'éviter toute exposition prolongée à des sources de chaleur directe, susceptibles d'altérer la surface.



### Recycled polypropylene Polypropylène recyclé

Clean polypropylene surfaces using a soft, clean cloth slightly dampened with clear water or water mixed with a neutral detergent. After cleaning, dry immediately with a dry cloth to limit the appearance of streaks or marks. Avoid abrasive products such as rough sponges or scouring creams, which can create micro-scratches. Cleaners containing alcohol should also be avoided, as they may alter the appearance and finish of the material.

Nettoyez les surfaces en polypropylène à l'aide d'un chiffon doux et propre légèrement humidifié avec de l'eau claire ou additionnée d'un détergent neutre. Après le nettoyage, séchez immédiatement avec un chiffon sec afin de limiter l'apparition de traces ou d'auréoles. Évitez l'utilisation de produits abrasifs, tels que les éponges rugueuses ou les crèmes à récurer, qui peuvent créer des micro-rayures. Les nettoyeurs contenant de l'alcool sont également à proscrire, car ils peuvent modifier l'aspect et la finition du matériau.

## CARE GUIDE ENTRETIEN



### Wood / Bois

#### Oak & walnut veneer Chêne & noyer plaqué

Wood veneer consists of a thin layer of natural wood applied to a stable core. For maintenance, dust regularly with a soft cloth. In case of stains, use a slightly damp cloth with a neutral detergent, then wipe immediately to prevent water marks. Avoid abrasive products, solvents and alcohol-based cleaners, which may damage the finish. Never allow water to sit on the surface, and protect the wood from prolonged direct sunlight and significant humidity variations to preserve its appearance.

Le bois plaqué consiste en une fine couche de bois naturel appliquée sur un support stable. Pour l'entretien, dépoussiérez régulièrement avec un chiffon doux. En cas de salissures, utilisez un chiffon légèrement humide avec un détergent neutre, puis essuyez immédiatement pour éviter les traces d'eau. Évitez les produits abrasifs, les solvants et les nettoyeurs contenant de l'alcool, qui peuvent endommager la finition. Ne laissez jamais l'eau stagner sur la surface et protégez le bois d'une exposition directe et prolongée au soleil ainsi que des variations importantes d'humidité pour préserver son aspect.



#### Solid oak Chêne massif

Solid oak is a natural, living material whose appearance may evolve slightly over time. To preserve it, dust regularly with a soft cloth. For small stains, use a slightly damp cloth with a neutral detergent, then dry immediately to prevent moisture from penetrating the wood. Avoid abrasive products, solvents, alcohol or rough sponges, which may damage the surface. Protect solid oak from direct sunlight, heat sources and significant humidity changes to maintain its appearance and durability.

Le chêne massif est un bois naturel et vivant, dont l'aspect peut évoluer légèrement avec le temps. Pour le préserver, dépoussiérez régulièrement avec un chiffon doux. En cas de petites tâches, utilisez un chiffon légèrement humide avec un détergent neutre, puis séchez immédiatement afin d'éviter que l'humidité ne pénètre dans le bois. Évitez les produits abrasifs, les solvants, l'alcool ou les éponges rugueuses, qui peuvent endommager la surface. Protégez le chêne massif d'une exposition directe au soleil, des sources de chaleur et des variations importantes d'humidité pour en conserver l'aspect et la durabilité.

## CARE GUIDE ENTRETIEN



### Wood / Bois

#### White laminated plywood Stratifié blanc

White laminated plywood is a durable finish with increased resistance to everyday use. Dust regularly with a soft, dry cloth. In case of dirt, use a slightly damp cloth with a neutral detergent, then dry immediately to prevent moisture infiltration. Avoid abrasive products, solvents, alcohol and rough sponges, which may damage the surface or dull the finish. Protect laminated from prolonged direct sunlight and significant humidity variations to preserve its colour and durability.

Le stratifié est un revêtement durable souvent utilisé pour les plateaux de table, offrant une excellente résistance aux usages quotidiens. Pour l'entretenir, nettoyez régulièrement avec un chiffon doux et sec. En cas de salissure, utilisez un chiffon légèrement humide avec un détergent neutre, puis séchez immédiatement pour éviter toute infiltration d'humidité. Évitez les produits abrasifs, les solvants, l'alcool et les éponges rugueuses, qui peuvent endommager la surface ou ternir la finition. Protégez le stratifié d'une exposition directe et prolongée au soleil, ainsi que des variations importantes d'humidité, afin de préserver sa couleur et sa durabilité.



#### Old oak Bois ancien

Old oak is made from salvaged pieces, giving it a unique character and natural patina. To preserve it, dust regularly with a soft, dry cloth. In case of dirt, clean with a slightly damp cloth and a neutral detergent, then dry immediately to avoid moisture penetration. Avoid abrasive products, solvents, alcohol and rough sponges, which may damage the finish. Irregularities and small marks are part of the charm of this wood and should not be considered defects. Also protect it from heat sources, direct sunlight and significant humidity changes to prevent cracking or warping.

Le bois ancien provient de pièces recyclées, ce qui lui confère un caractère unique et une patine naturelle. Pour le préserver, dépoussiérez régulièrement avec un chiffon doux et sec. En cas de salissure, nettoyez avec un chiffon légèrement humide et un détergent neutre, puis séchez immédiatement pour éviter toute infiltration d'humidité. Évitez les produits abrasifs, les solvants, l'alcool et les éponges rugueuses, qui pourraient altérer sa finition. Les irrégularités et petites marques font partie du charme de ce bois et ne doivent pas être considérées comme des défauts. Protégez-le également des sources de chaleur, du soleil direct et des variations importantes d'humidité afin de prévenir fissures et déformations.

## CARE GUIDE ENTRETIEN



### Fabric / Tissu

#### Gabriel, Rohi & Kvadrat fabric Tissu Gabriel, Rohi & Kvadrat

The fabrics used for our seating are designed to combine comfort, durability and resistance. For everyday care, vacuum regularly using a textile nozzle to remove dust and lint, and occasionally smooth the fabric by hand to maintain its appearance. In case of stains, blot immediately with a clean cloth without rubbing. Use only lukewarm water or a neutral detergent suitable for textiles. Avoid concentrated products, bleach, solvents or any aggressive cleaners that may damage the colour or fibres. Avoid overly intensive spot cleaning, which may cause water rings. For stubborn stains, professional textile cleaning is recommended.

Les tissus de nos assises sont conçus pour allier confort, résistance et durabilité. Pour l'entretien quotidien, dépoussiérez régulièrement à l'aide de l'embout textile de l'aspirateur afin d'éliminer poussière et peluches, et lissez occasionnellement le tissu avec la main pour préserver son aspect. En cas de tâche, tamponnez immédiatement avec un chiffon propre sans frotter. Utilisez uniquement de l'eau tiède ou un détergent neutre adapté aux textiles. Évitez les produits concentrés, l'eau de Javel, les solvants ou tout nettoyage agressif pouvant altérer la couleur ou la fibre. Évitez un nettoyage localisé trop intensif, qui peut provoquer des auréoles. Pour les tâches tenaces, il est recommandé de faire appel à un professionnel du nettoyage textile.

### Outdoor / Extérieur

#### Recycled plastic Plastique recyclé

Recycled plastic is a delicate material that should be cleaned with a soft damp cloth. The use of aggressive chemical products is not recommended to avoid damaging the surface. Recycled polypropylene, used for our SSDr chairs, features a UV-stabilizing treatment that improves the material's and color's resistance to natural light exposure. A slight evolution of the shade may nevertheless occur over time, especially in cases of prolonged exposure.

Le plastique recyclé est une matière délicate qui s'entretient avec un chiffon doux humide. L'usage de produits chimiques agressifs est fortement déconseillé pour éviter toute détérioration de la surface. Le polypropylène recyclé, utilisé pour nos chaises SSDr, intègre un traitement anti-UV, permettant une meilleure tenue du matériau et de la couleur face à l'exposition naturelle lumineuse. Une légère évolution de la teinte reste toutefois possible avec le temps, notamment en cas d'exposition prolongée.

#### Steel Acier

The steel is protected by a high-end anti-corrosion treatment that preserves it from external aggression. Simply clean with lukewarm water, a neutral detergent and a soft cloth.

L'acier est protégé avec un traitement anticorrosion haut de gamme qui le préserve des agressions extérieures. Un entretien à l'eau tiède avec un détergent neutre et un chiffon doux est suffisant.



## CARE GUIDE ENTRETIEN



## Outdoor / Extérieur

The durability of your furniture depends on weather conditions and usage. To preserve it, store it in a dry, well-ventilated area during winter, and protect it from scratches and impacts. After exposure to rain or humidity, rinse the furniture with clean water (preferably at the end of the season rather than after each use) to remove dirt and limescale deposits, then dry thoroughly with a soft cloth. Avoid leaving water standing on surfaces: if possible, slightly tilt the furniture to allow water to drain and prevent marks or oxidation. Avoid placing very hot objects directly on the surface, as this may damage the cathodization treatment of the steel and alter the finish. The use of protective covers is not recommended, as moisture can become trapped between the cover and the furniture, accelerating material ageing. Regular maintenance and these simple precautions will help extend the beauty and durability of your Outdoor furniture, even when used outdoors.

The Midi, Panorama and Moka collections has been designed and developed using robust, high-quality materials to stand the test of time. However, daily use in seaside environments is not recommended, as this remains a particularly harsh setting for metal furniture.

La durabilité de votre mobilier dépend des conditions météorologiques et de son utilisation. Pour le préserver, rangez-le dans un endroit sec et bien ventilé pendant l'hiver, et protégez-le contre les rayures et les chocs. Après chaque exposition à la pluie ou à l'humidité, rincez le mobilier à l'eau douce (en fin de saison plutôt qu'après chaque utilisation) douce pour éliminer les dépôts de saleté et de calcaire, puis essuyez le soigneusement avec un chiffon doux. Évitez de laisser l'eau stagner sur les surfaces : si possible, inclinez légèrement le mobilier pour faciliter l'écoulement de l'eau et prévenir les traces ou l'oxydation. Évitez de poser directement des objets très chauds sur la surface, car cela peut endommager le traitement de l'acier par cathodisation et altérer la finition. L'usage de bâches est déconseillé, car l'humidité peut rester piégée entre la protection et le mobilier, ce qui accélère le vieillissement des matériaux. Un entretien régulier et ces précautions simples permettent de prolonger la beauté et la durabilité de votre mobilier Outdoor.

Les collections Midi, Panorama et Moka ont été pensée et développée avec des matériaux robustes et de qualité pour résister au temps. Néanmoins, l'utilisation quotidienne en front de mer n'est pas recommandée car cela reste un environnement particulièrement agressif pour le mobilier métallique.

## BESPOKE SERVICES SERVICES SUR-MESURE



For projects requiring specifications that are not available in our standard collections, Tiptoe offers a bespoke service. For any specific request, please contact your usual sales representative. For detailed pricing of our custom-made options, please refer to the current 2026 B2B price list.

Pour les projets nécessitant des spécifications qui ne sont pas disponibles dans nos collections standard, Tiptoe propose un service sur-mesure. Pour toute demande spécifique n'hésitez pas à vous rapprocher de votre contact commercial. Pour connaître la tarification spécifique de nos options sur-mesures, veuillez vous reporter au tarif B2B 2026 en vigueur.

### Fabric

#### Tissu

For our seating collections, Tiptoe works with leading European textile editors such as Rohi, Kvadrat and Gabriel. Depending on the seating collection, it is possible to customize:

- Fabric
- Color
- Certain finishes

Available options vary according to the models and their specific technical requirements.

Pour ses assises, Tiptoe travaille avec des éditeurs textiles européens de référence tels que Rohi, Kvadrat et Gabriel. Selon la collection d'assises, il est possible de personnaliser :

- Le tissu
- La couleur
- Certaines finitions

Les possibilités varient selon les modèles et les spécificités techniques propres à chaque collection.

### Materials

#### Matériaux

Depending on the collection, it is possible to customize the materials used, including:

- Selection of different wood species and finishes

Selon les collections, il est possible de personnaliser les matériaux utilisés :

- Choix de différentes essences de bois et de finitions

### Dimensions

Some collections can be customized in terms of dimensions (height, width, depth). These adjustments remain subject to technical, structural, and usage constraints in order to ensure the stability, durability, and safety of the final product.

Certaines collections peuvent être adaptées en termes de dimensions (hauteur, largeur, profondeur). Ces ajustements restent soumis à des contraintes techniques, structurelles et d'usage, afin de garantir la stabilité, la durabilité et la sécurité du produit final.



## Colors Couleurs

Color customization mainly applies to our steel components (stained wood available upon request). These parts can be produced in specific colors through custom powder coating, beyond the standard collection color range. Colors are selected from color charts and are subject to technical constraints related to the manufacturing process and minimum order quantities. Customization options depend on the selected collection and specific production constraints.

La personnalisation des couleurs concerne principalement nos pièces en acier (bois teinté disponible sur demande). Celles-ci peuvent être réalisées dans des teintes spécifiques grâce à un thermolaquage personnalisé, au-delà des coloris proposés dans la collection standard. Les couleurs sont sélectionnées sur nuancier et soumises à des contraintes techniques liées au procédé de fabrication et aux quantités minimales. Les options de personnalisation dépendent de la collection concernée et des spécificités techniques de production.

For any other requests not listed above, please contact us.  
Pour toute autre demande non citée ci-dessus, nous consulter.





# A NEW STANDARD FOR FRENCH DESIGN

## CONTACT

---

### EUROPE

Contract  
projects@tiptoe.fr  
Retailers  
sales@tiptoe.fr

Paris showroom  
46 rue du Faubourg Saint-Martin,  
75010, Paris  
Paris flagship store  
49 rue Etienne Marcel,  
75001, Paris

---

### NORTH AMERICA

Tiptoe is distributed  
by FERMOB in North America  
commercialefermobusa.com

FERMOB USA showroom  
New York Design Center  
200 Lexington Avenue  
New York, NY 10016

---

tiptoe.fr/en  
@tiptoedesign

Digital library:  
tiptoe.presscloud.com

