



DECIBEL
by JOHANSON

Silence through design

Every day we are surrounded by all sorts of sounds, from whirring fans, chatting colleagues and ringing phones to the background noise of a radio. Unwanted noise can have a negative effect on people, disrupting concentration and increasing stress levels.

Decibel by Johanson specialises in creating a better environment for everyone to work and live in.

We develop sound absorbers and acoustic diffuser panels that really do make a difference. Our products are the result of many years' experience of design and close collaboration with acoustic engineers, backed up by systematic acoustic analyses and tests conducted in accordance with approved standards.

Of the five senses that humans have evolved – smell, hearing, taste, touch and sight – three are particularly important for survival. These are smell, hearing and sight. At Decibel we have chosen to focus our work on hearing and on issues that are key to understanding how sound is transmitted, perceived and absorbed.

Human hearing developed primarily to alert us to dangers and to localise the source of a noise so that we could determine the best escape route. Today the situation is very different.

We live in an information society where it is absolutely essential to be able to hear what is being said in order to acquire and systematise information.

To mitigate distracting noise Decibel by Johanson has developed sound absorbers that make it easier to concentrate on the task in hand. We believe that emulating natural features of the outdoor environment and recreating them in indoor spaces is a relevant way to recognise the value of all our senses – eye, ear and soul.

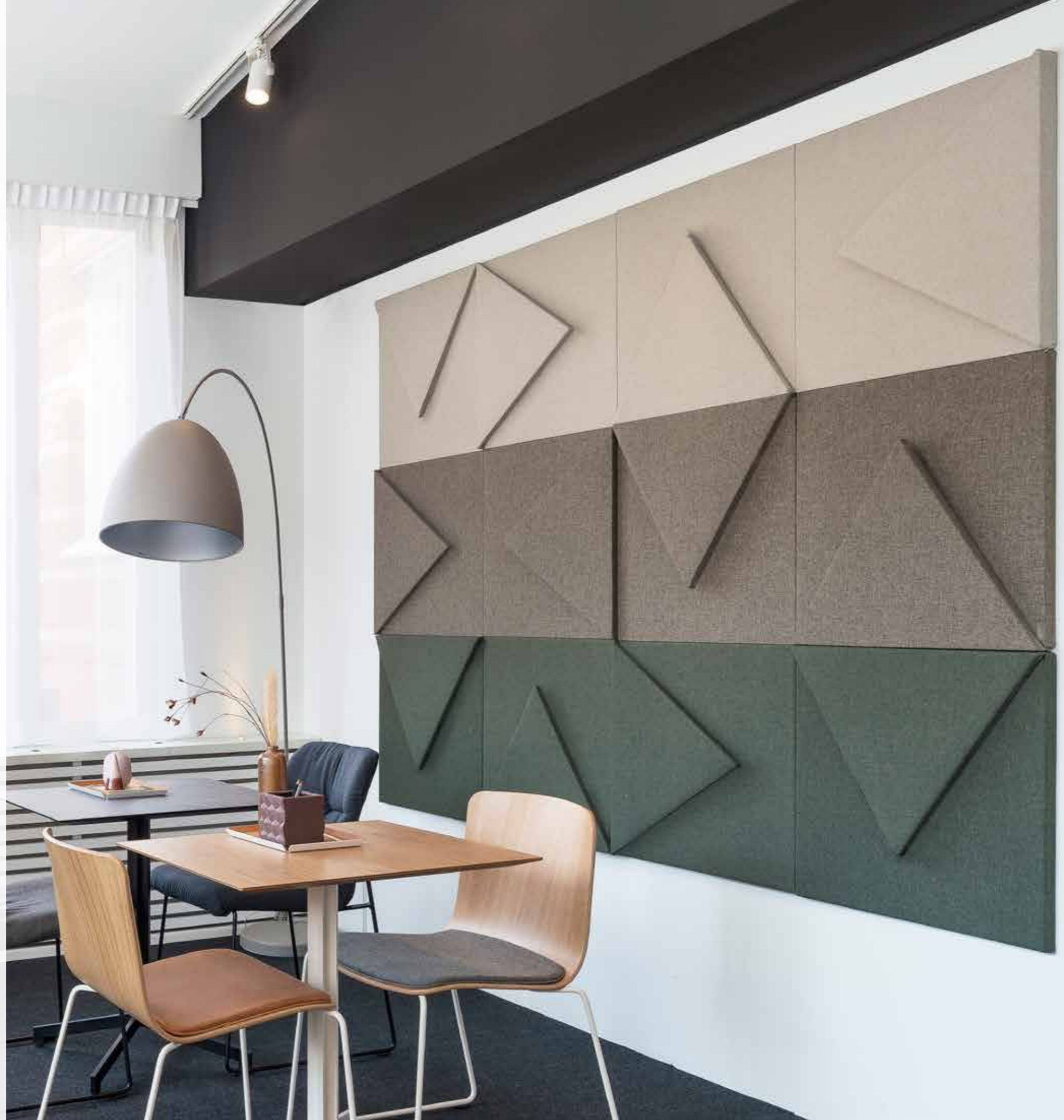

THE SCIENCE AND UNDERSTANDING OF SOUND

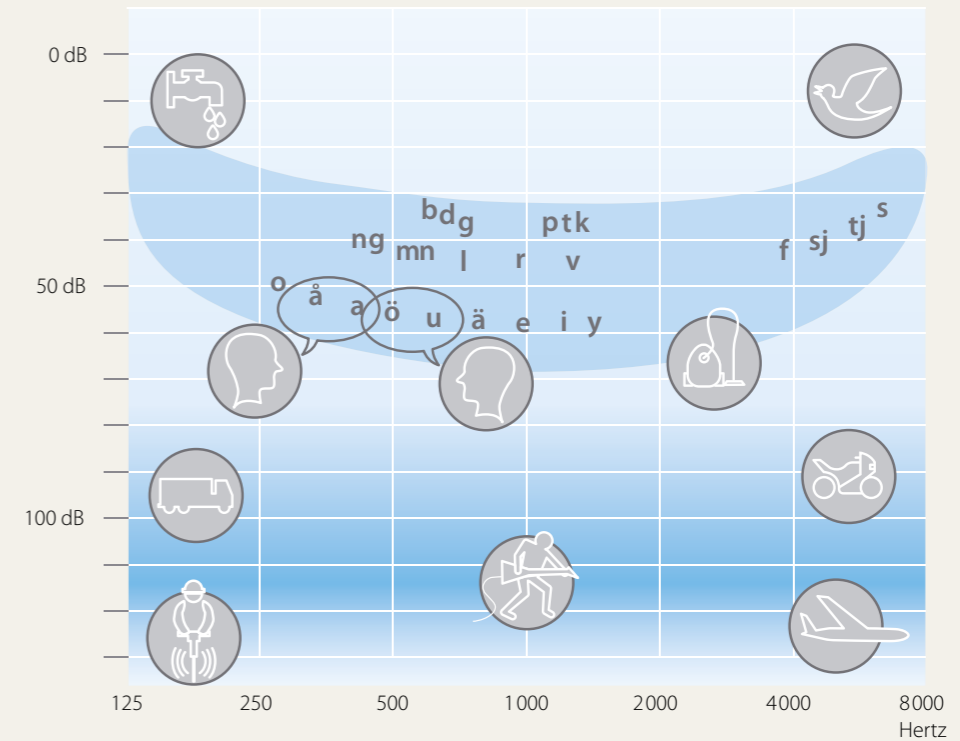

The human ear can detect frequencies between 20 and 20,000 Hertz (Hz). The voice frequency, however, is approximately 125-8,000 Hz. Vowels such as A, E, O, I and U are pronounced loudest, so these vowels belong to a low frequency band. Voiced consonants such as M, R, V and B are in the medium frequency range, while the unvoiced consonants F, P, S and T are in the high frequency band, with F, T and S being particularly difficult to discern.

Sound is energy. Sound needs air in order to travel from point A to point B. It also needs a 'trigger' that causes an object to vibrate, such as a hammer striking a nail or a finger plucking a guitar string.

A third component in the transmission of sound is our ear and its ability to detect the sounds we hear. Different sounds are the result of contrasts in energy and variations in wavelengths. A bass sound has more energy and longer wavelengths. That's why, during a concert, we may experience pressure on our chest from the vibration of

the bass: this is because the air is, literally, being pressed against our body. The fact that the high energy content of a bass note can travel a long way may sometimes be perceived as disturbing. High-pitched sounds, however, have less energy and shorter wavelengths, so their energy dissipates quickly. Imagine, for example, the scenario of overhearing a conversation in the office next door. It is difficult to determine what is being said, because higher-pitched sounds are less able to penetrate the wall than those with a low pitch. The effect can be even more disturbing if one of those talking has a deep (bass) voice: it's

not possible to distinguish any consonants, so all that we hear is a low 'rumbling'.

All of us have our own inbuilt hearing threshold, which is affected in different ways. Loud noises (in excess of 120 dB) can cause discomfort and pain – and our ears are less forgiving than our eyes. If our eyes are exposed to very bright light, we can squint or blink, and the consequence may be no more than a temporary halo in our field of vision. Loud noises, however, can seriously damage our hearing, causing tinnitus or leading to other permanent hearing impairments.

For most of us, poor light is preferable to an uncomfortable noise level.

Hearing also deteriorates with age. It is quite common for our hearing acuity to diminish with increasing rapidity as we grow older, making it hard for us to distinguish between words such as 'sound', 'found' and 'round'. Instead we either have to use context and the speaker's lip movements, or increase the volume in some way in order to interpret what is being said.

THE FUNCTION OF SOUND ABSORBERS IN DIFFERENT ENVIRONMENTS

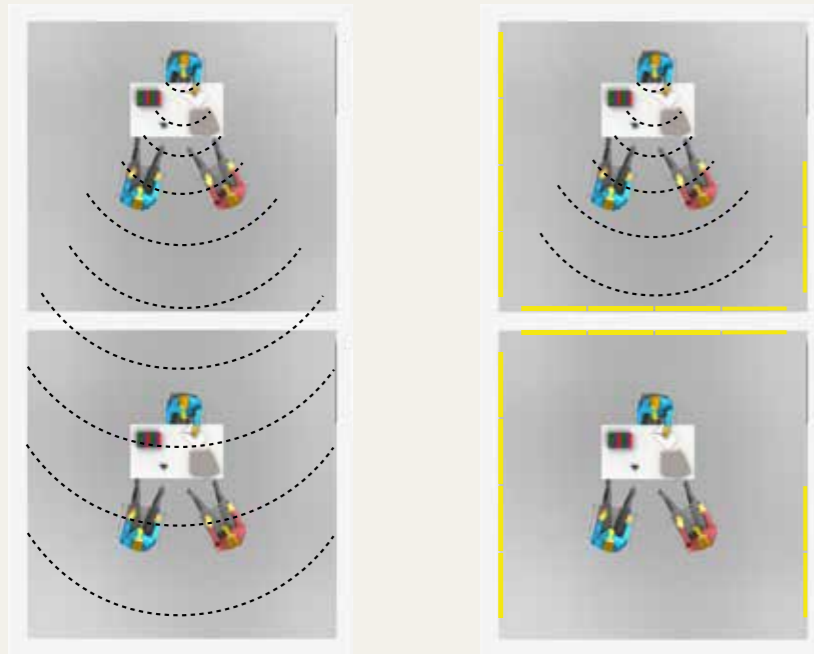

OFFICES

In a room without sound absorbers there is always a certain amount of unwanted background noise and half-heard conversations that are perceived as disturbing.

Solution: We install sound absorbers on both side-walls in order to reduce the overall noise level. We also fit sound absorbers on one non-parallel surface to improve the acoustic environment even further by making it easier for workers to concentrate and to distinguish what is being said to them.

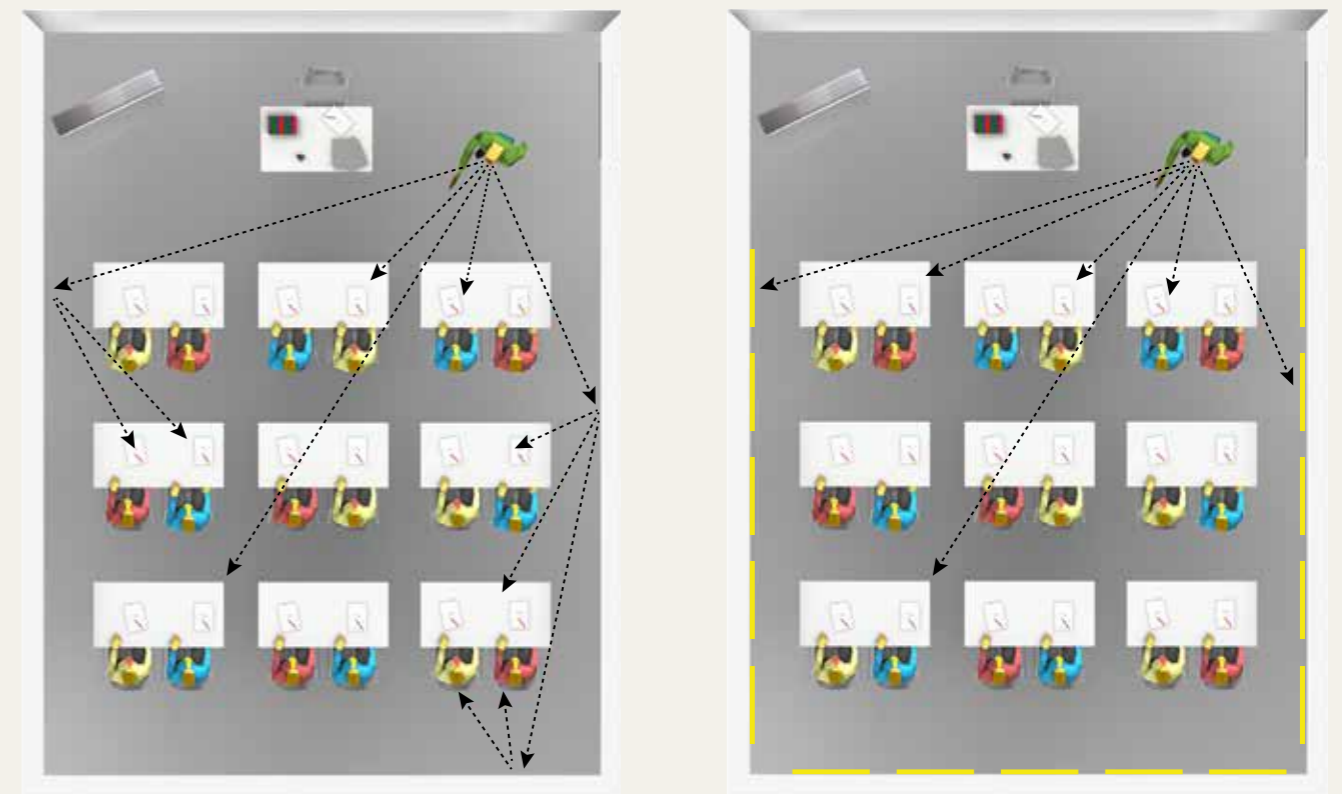

CLASSROOMS

In a classroom there is usually just one main source of sound (the teacher's voice). This can pose a serious problem, because while pupils on the front row hear only direct sound, those further back in the room also have to cope with reflected sounds that bounce off the walls and ceiling.

Solution: The illustrations above show how energy in the sound waves transmitted by the teacher is absorbed by the panels and captured within the absorbent material instead of being reflected. As all those in the room now hear only direct sound, this increases speech clarity and understanding.

UNIQUE COLLABORATION

The Ecophon Inside™ symbol guarantees that a product bearing this mark has been developed in conjunction with Ecophon. The sound-absorbent materials are designed and manufactured to satisfy criteria for optimum technical performance and a visually appealing form. Both core and surface materials have been specially chosen to meet the most stringent quality standards.

Our carefully engineered designs and approved eco-friendly materials provide an effective answer to the challenges of today's noisy world. All our products have been painstakingly tested by accredited laboratories in accordance with the latest standards for the relevant market. Production processes for the various components are environmentally certified according to ISO 14001 and all manufacturing is carried out in house in Hyllinge and Markaryd in Sweden.

Ecophon Inside™ is a registered trademark and must not be copied or used in any way without prior approval from Saint-Gobain Ecophon AB.



DECIBEL ACOUSTIC PANELS

FREQUENCY

The gently rounded lines of Frequency and the many different shapes and sizes of the panels open up endless opportunities. Frequency comes in a total of 15 sizes and depths.



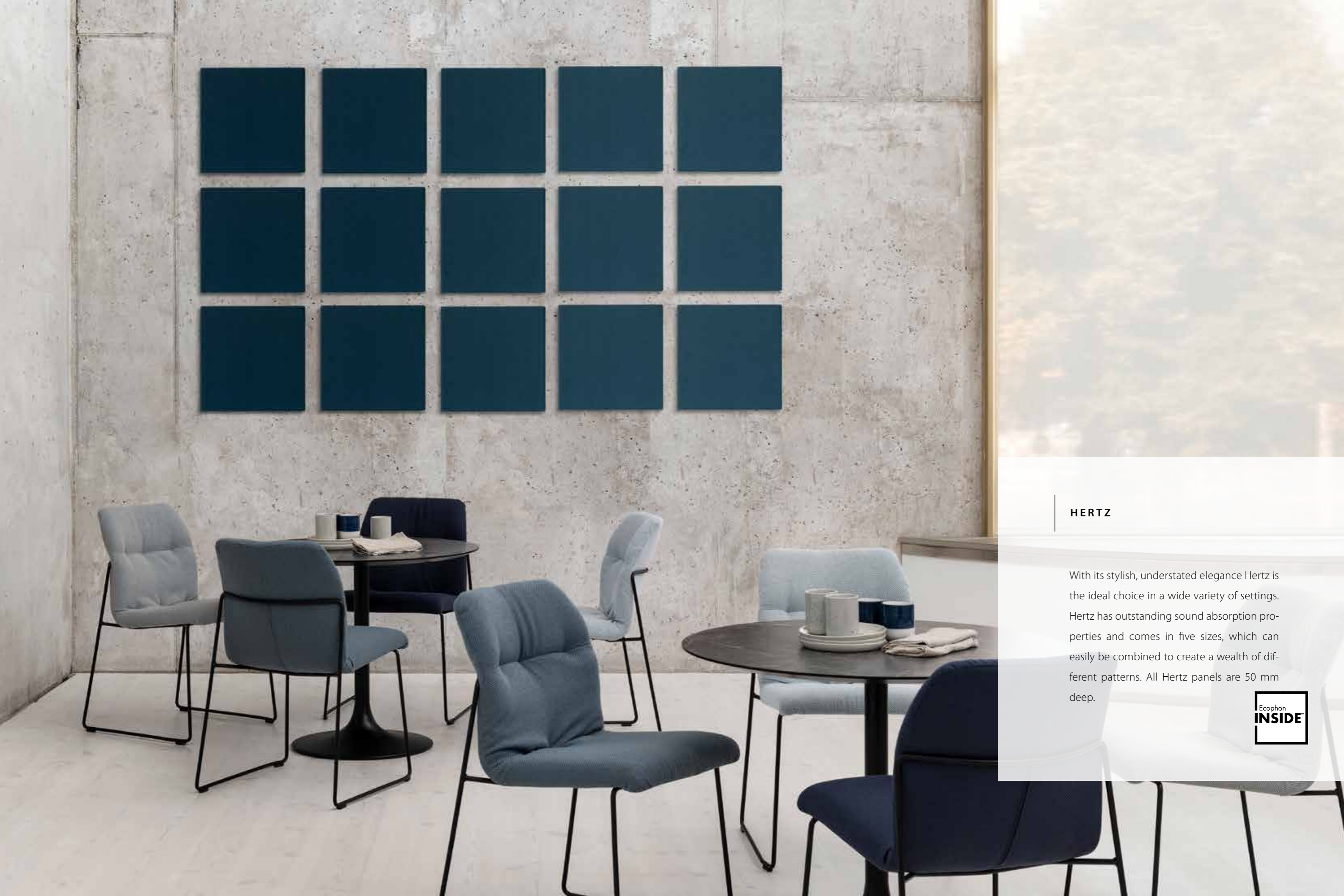

HERTZ

With its stylish, understated elegance Hertz is the ideal choice in a wide variety of settings. Hertz has outstanding sound absorption properties and comes in five sizes, which can easily be combined to create a wealth of different patterns. All Hertz panels are 50 mm deep.



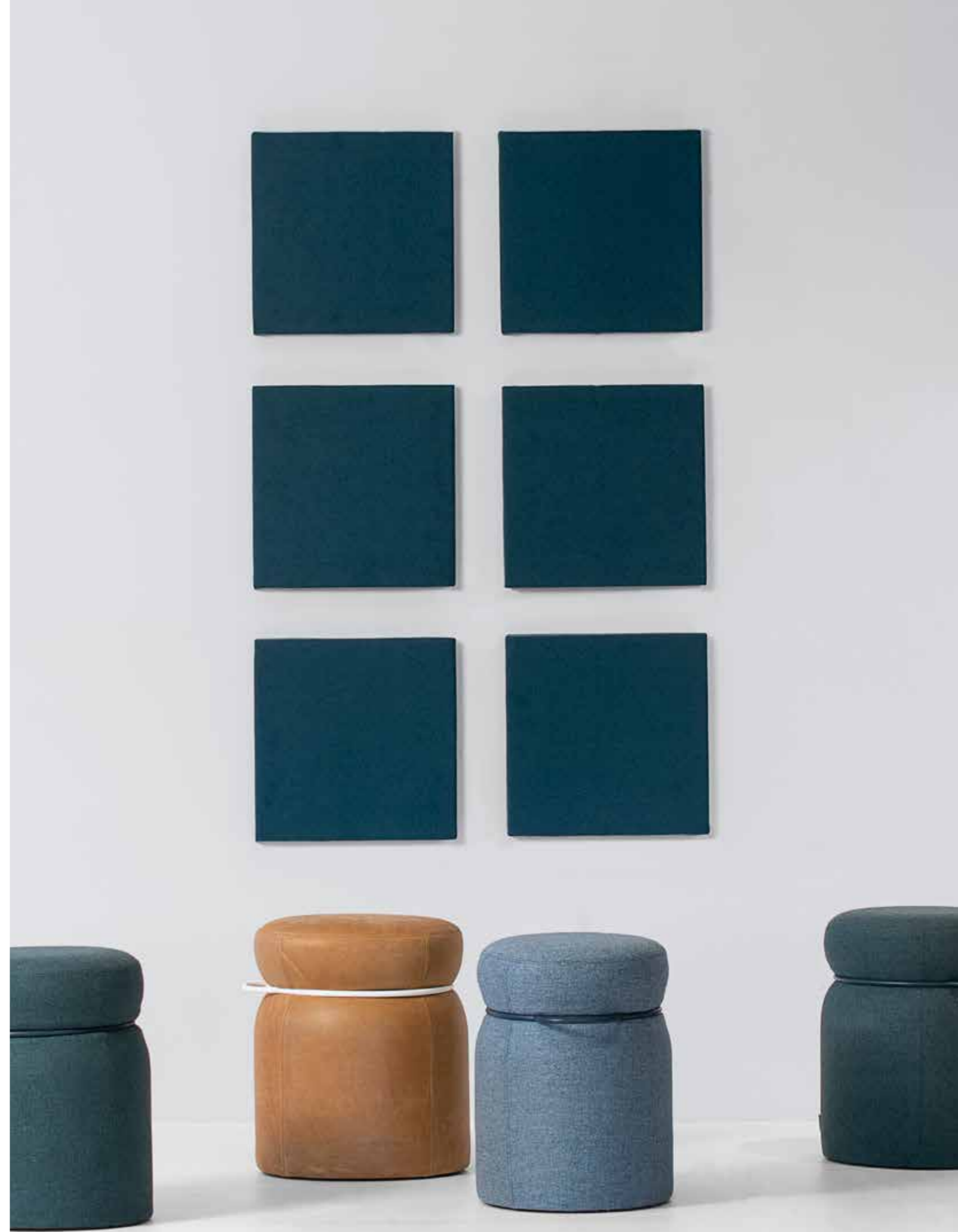



THE FRAME SERIES

CHESTERFIELD

LOOP

ROMB

CHESTERFIELD

DESIGN - JOHAN LINDSTÉN

The name and inspiration for this design come from the iconic, traditional Chesterfield sofa – a timeless design that has become synonymous with deep-buttoned quilting. The height differences of the quilting give the sound absorber its characteristic look, while also enhancing its acoustic and absorbent properties.

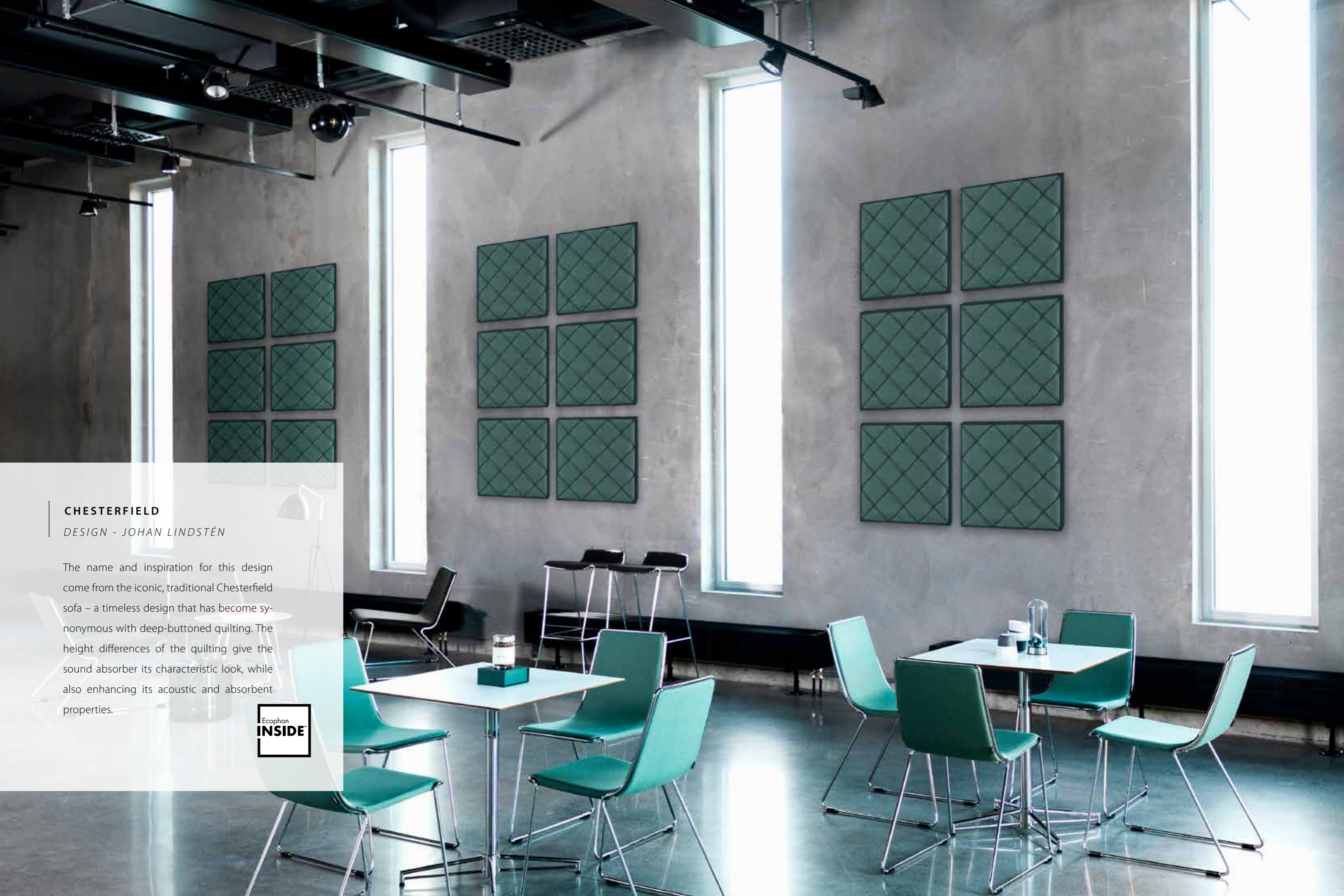

LOOP

DESIGN - JOHAN LINDSTÉN

Loop's four identical arcs work together to create a geometric basis for expansion. Depending on how you place Loop, you can vary the look of the finished design, perhaps even offsetting the panels to create the impression of waves billowing across the wall.



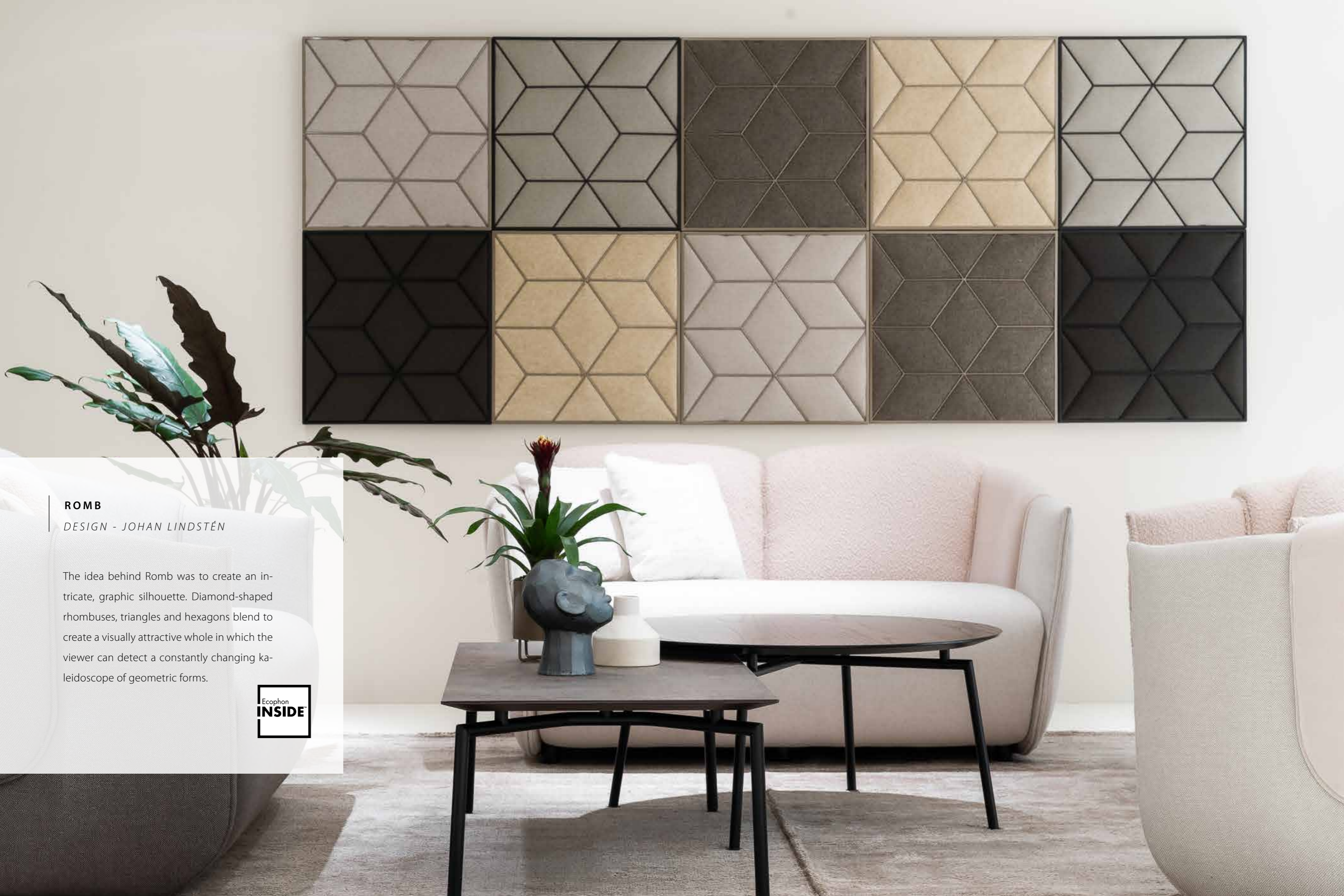

ROMB

DESIGN - JOHAN LINDSTÉN

The idea behind Romb was to create an intricate, graphic silhouette. Diamond-shaped rhombuses, triangles and hexagons blend to create a visually attractive whole in which the viewer can detect a constantly changing kaleidoscope of geometric forms.





ILLUSION 120 / 60
DESIGN - CORY GROSSER

The ingenious 'pleated' design ensures the effectiveness of Illusion sound absorbers. The pleats create a larger exposed surface, while the cavity behind provides the necessary air space for the panels to work effectively in the medium frequency range. Illusion is available in two sizes.





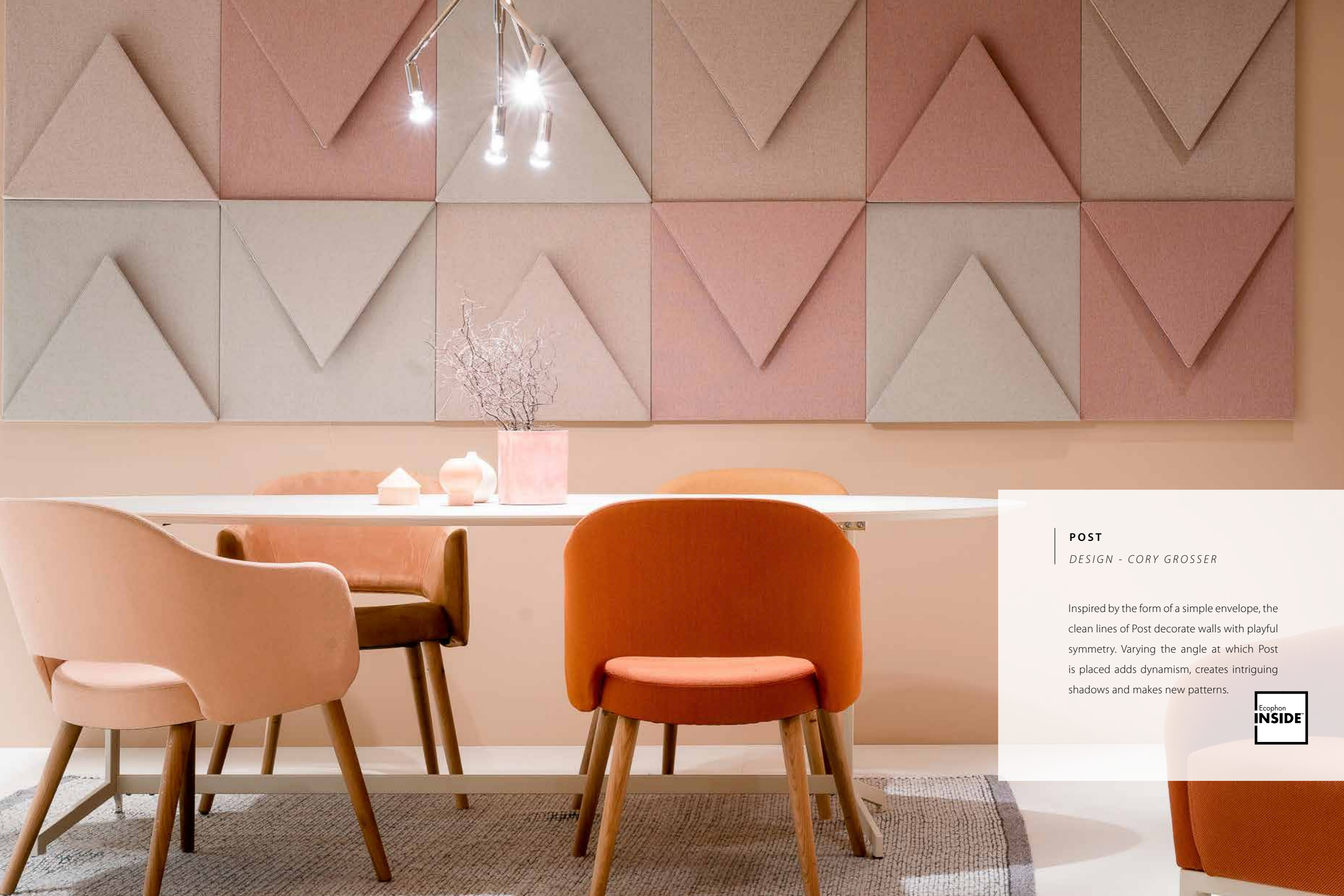

POST

DESIGN - CORY GROSSER

Inspired by the form of a simple envelope, the clean lines of Post decorate walls with playful symmetry. Varying the angle at which Post is placed adds dynamism, creates intriguing shadows and makes new patterns.





CLAMP

*DESIGN - ANDREA WEITZ
JENS WENDLAND*

Clamp is a series of sound absorbers for walls, ceilings and floor-mounting. It owes its name to the bracket or clamp that holds the sound-absorbing panel in place. With a choice of 400 RAL colours, different fabrics and surface coverings, and panels that come in a variety of shapes and sizes, the opportunities for creating unique settings are almost endless.



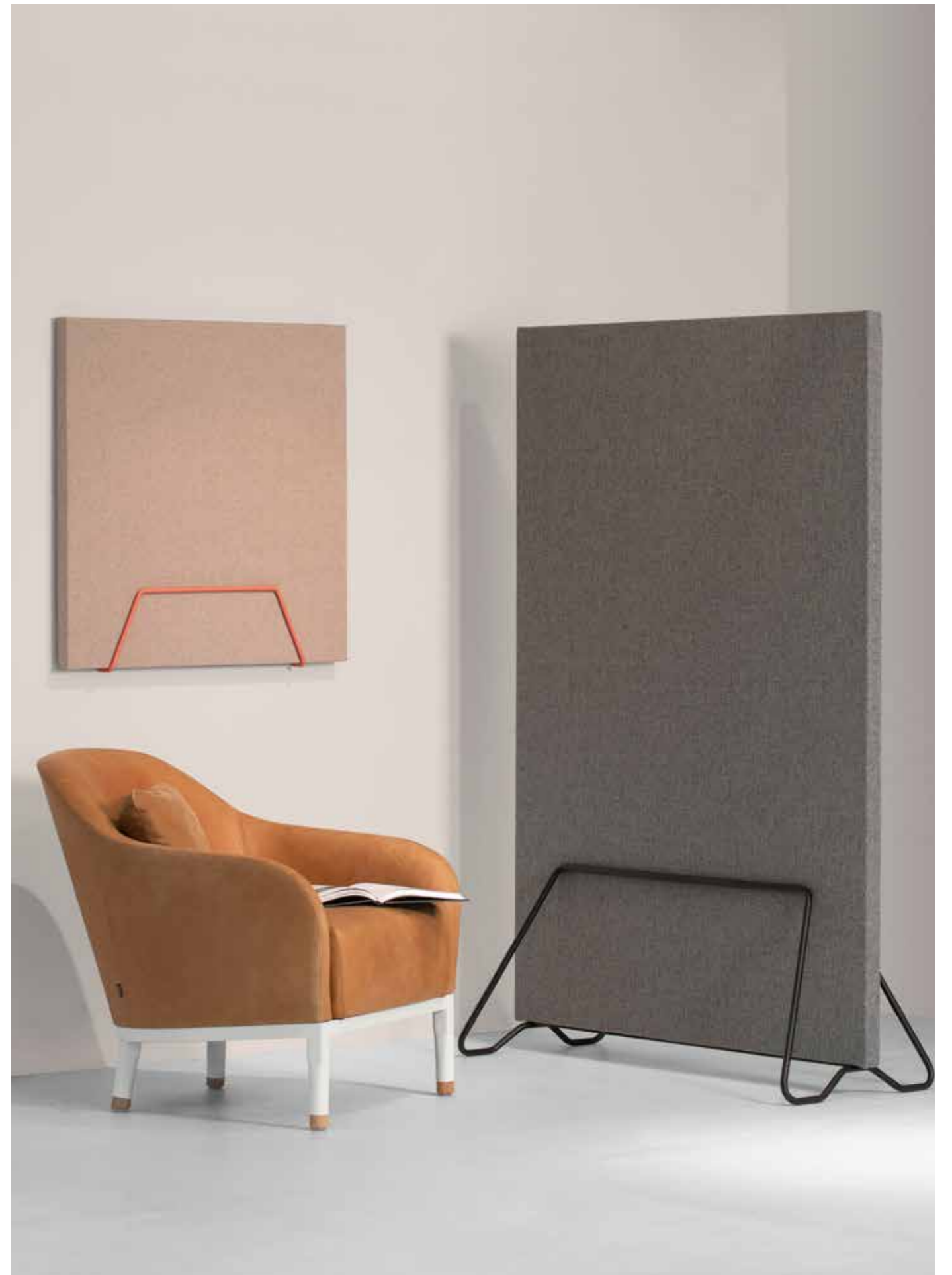



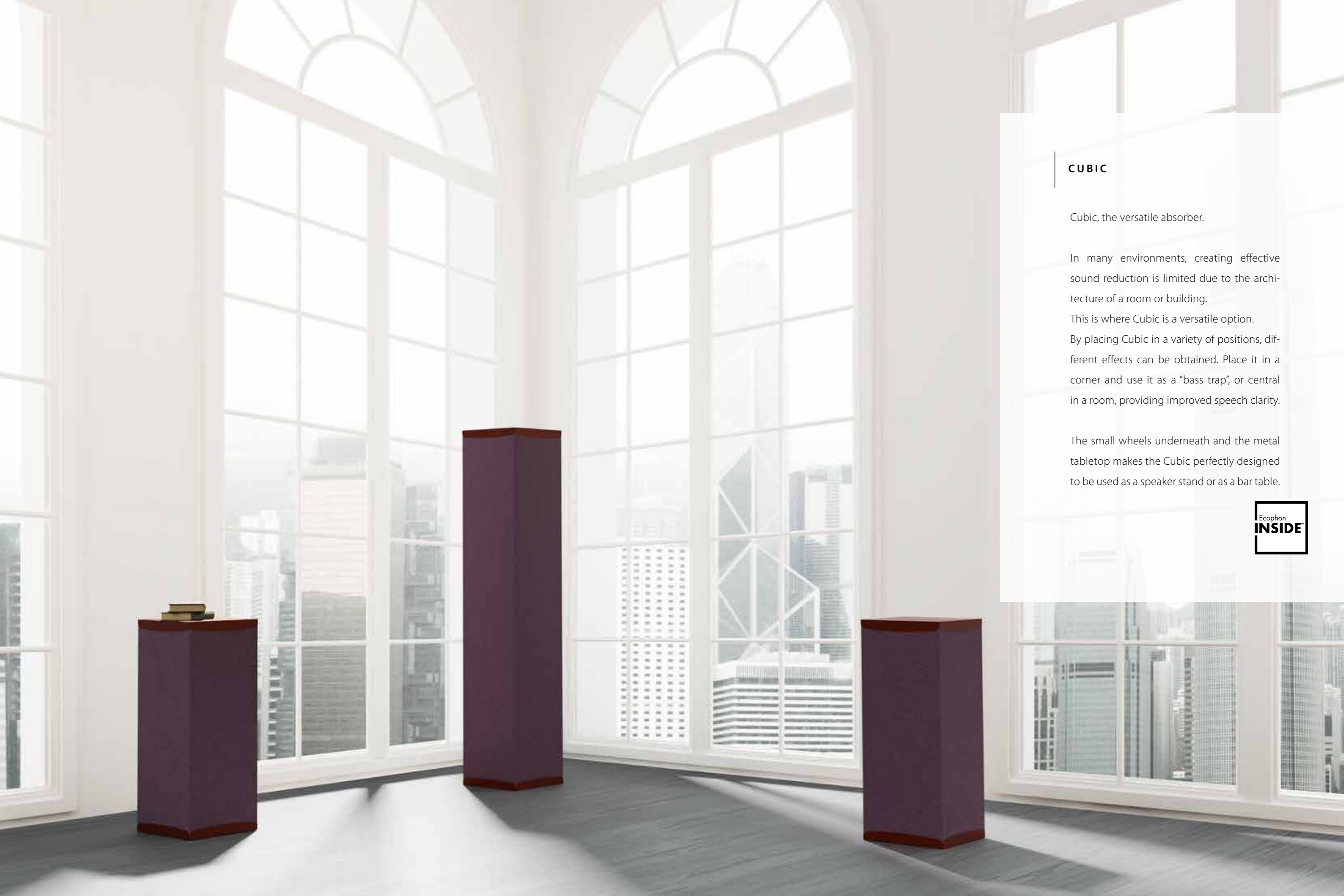

CUBIC

Cubic, the versatile absorber.

In many environments, creating effective sound reduction is limited due to the architecture of a room or building.

This is where Cubic is a versatile option.

By placing Cubic in a variety of positions, different effects can be obtained. Place it in a corner and use it as a "bass trap", or central in a room, providing improved speech clarity.

The small wheels underneath and the metal tabletop makes the Cubic perfectly designed to be used as a speaker stand or as a bar table.





UNIQUE TIMELESS DESIGN

Wall-mounted sound-diffusion panels reduce background noise and travelling voices. They are simply installed on the wall with the help of magnets. Available in black, dark grey, light grey, off white felt and selected fabrics.

DECIBEL DESIGN PANELS

LEAVES

DESIGN - JOHAN LINDSTÉN

This design panel, inspired by the natural form and beauty of leaves, also replicates the brilliant lustre of foliage.

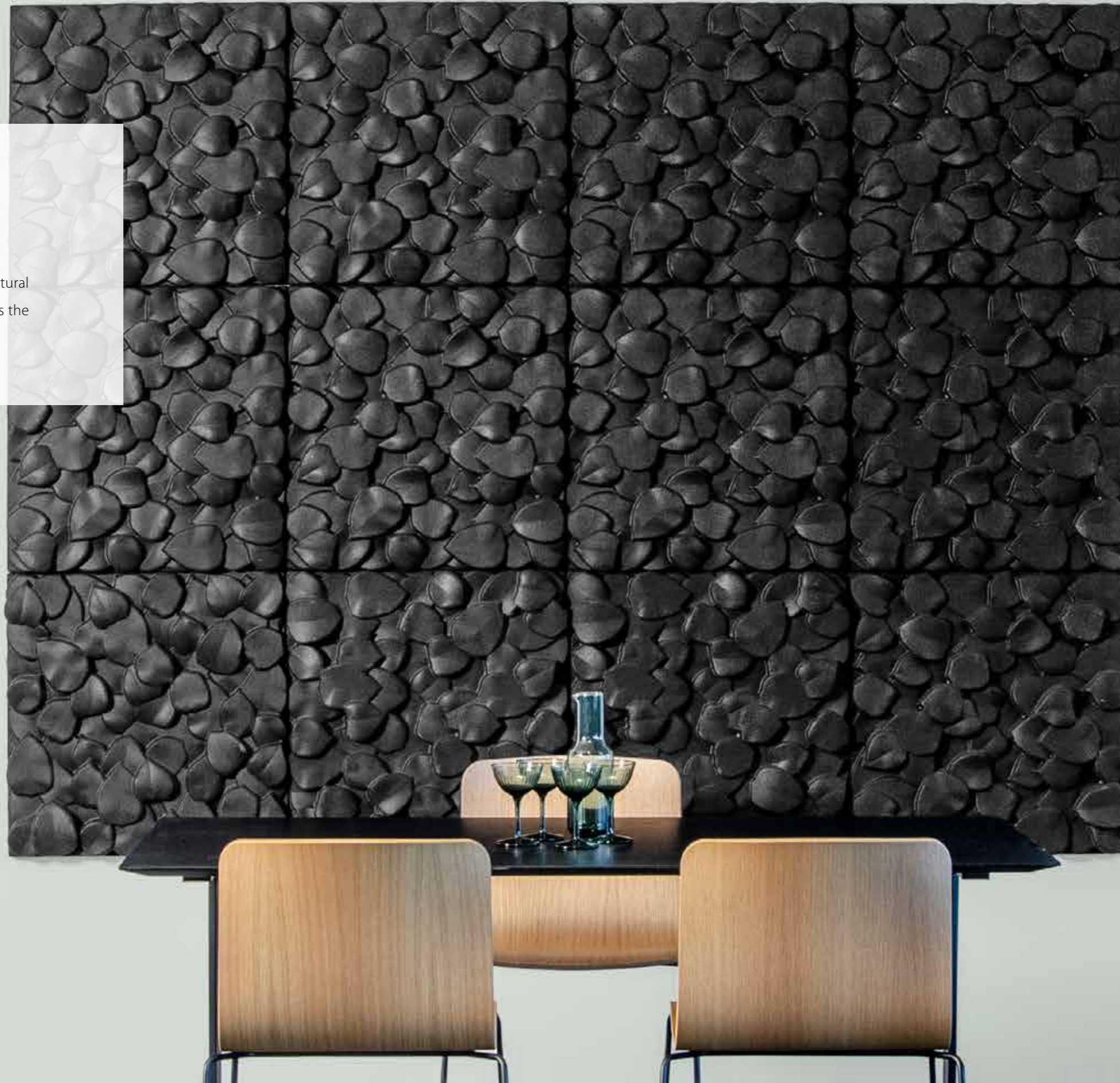



BEEHIVE RECTANGULAR & BEEHIVE
DESIGN - JOHAN LINDSTÉN

Inspired by the hexagon, one of nature's strongest and most ingenious shapes. Bees use a six-sided construction in their hives because it is strong and requires a minimum of material. Now this honeycomb pattern is available as a design panel and wall decoration.



RACE WALL

DESIGN - CORY GROSSER

Inspired by the dream of designing your very own race course, the epitome of accuracy and precision.



MOON

DESIGN - JOHAN LINDSTÉN

A wall-mounted sound diffusion panel with a pattern inspired by the surface of the moon, formed by the impacts of comets, asteroids and meteoroids over the course of millions of years.



PEBBLE

DESIGN - JOHAN LINDSTÉN

Pebble design panel owes its inspiration to the natural beauty and infinite variations of pebble beaches.



CROPFIELD

DESIGN - JOHAN LINDSTÉN

In the south of Sweden apparently endless plains and large open fields extend over the landscape like a gigantic patchwork. The erratic pattern of irregular shapes and the varying structures of these farmlands have provided the inspiration for Cropfield and given the product its name.

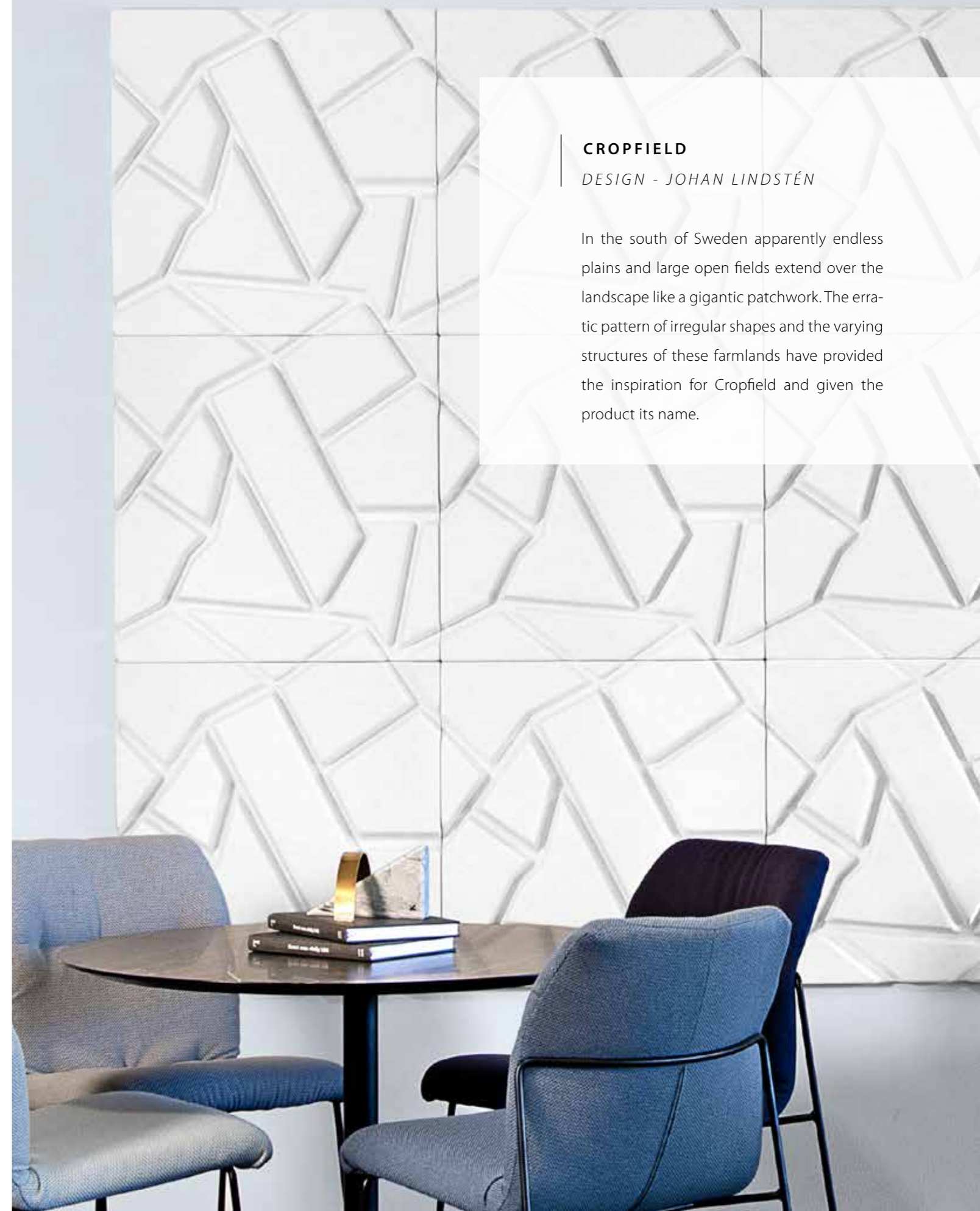

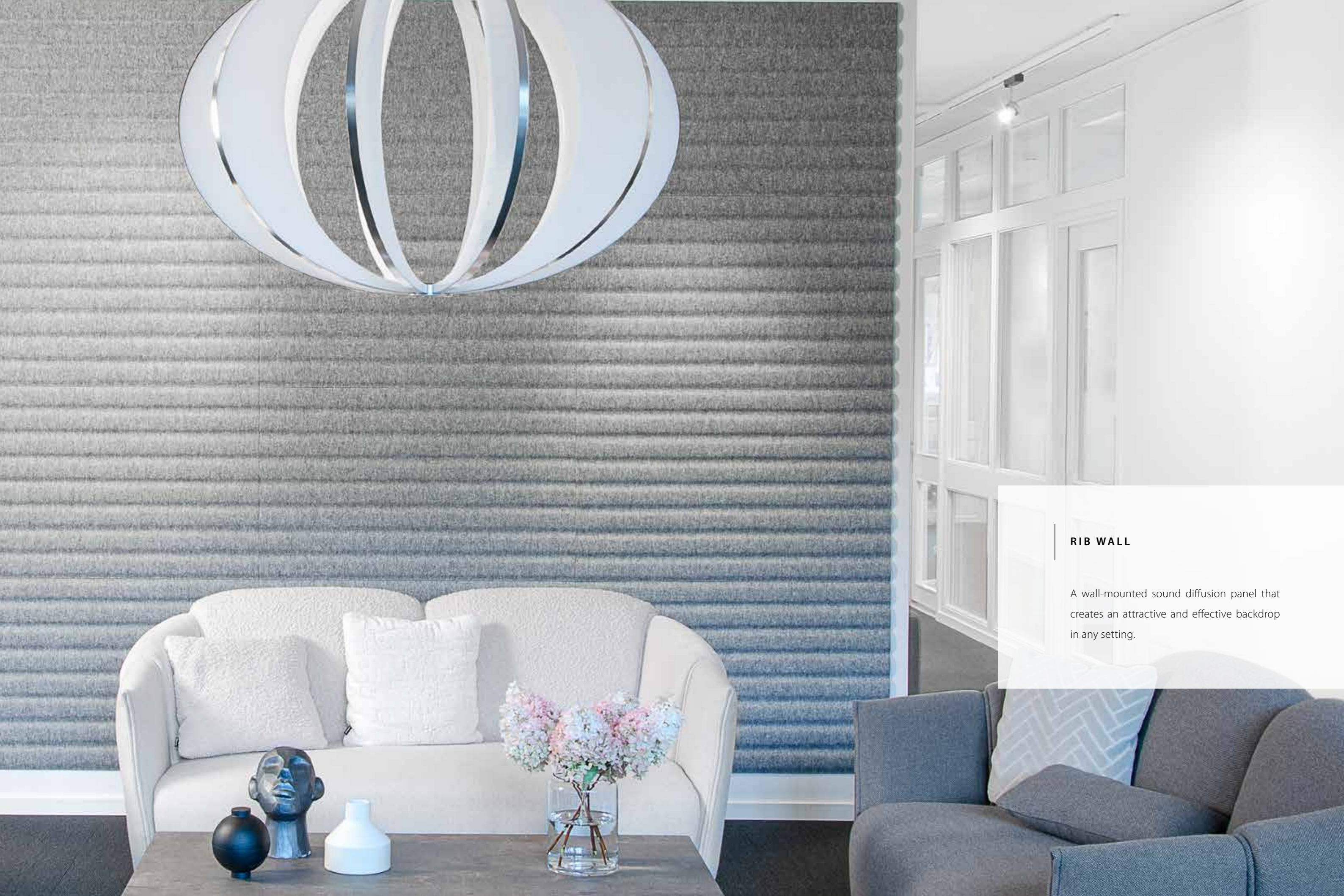

RIB WALL

A wall-mounted sound diffusion panel that creates an attractive and effective backdrop in any setting.

DECIBEL FACTS PRODUCT DETAILS INSTALLATION

FREQUENCY

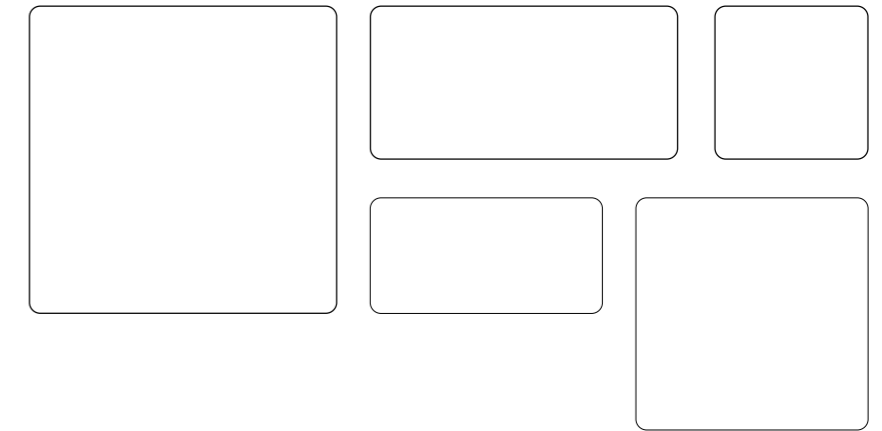

| | | | | | |
|-------------|----------------|----------------|----------------|--------------|----------------|
| HEIGHT | 80 CM | 80 CM | 60 CM | 60 CM | 40 CM |
| WIDTH | 80 CM | 40 CM | 60 CM | 30 CM | 40 CM |
| TOTAL DEPTH | 4/8/12 CM | 4/8/12 CM | 4/8/12 CM | 4/8/12 CM | 4/8/12 CM |
| WEIGHT | 5,6/6,5/8,2 KG | 2,6/3,2/3,6 KG | 3,2/4,2/6,2 KG | 1,6/2/2,2 KG | 1,4/1,6/1,8 KG |

MATERIAL

Ecophon Inside
Back piece in MDF-board
Suspension with wooden beam is standard
Fabric

OPTIONS

Magnets for mounting, neodym 4 x ø20 x 6 mm
200 cm wooden beam when installing several panels in width
(not in combination with magnets)

ACOUSTIC PROPERTIES

Frequency in Hz

| 63 | 125 | 250 | 500 | 1000 | 2000 | 4000 | Aw |
|------|------|------|------|------|------|------|------|
| 0,02 | 0,17 | 0,62 | 1,16 | 1,16 | 1,09 | 1,01 | 0,95 |

Absorption Class A

Tested according to ISO 354 och ISO 11654

FIRE TEST

Frequency is tested according to EN ISO 11925-2

UPHOLSTERY MATERIAL

The fabrics for our sound absorbers are carefully selected and tested according to the standard set by all the manufacturers.

PG0

Camira Cara
Camira Carlow
Camira Fiji
Gabriel Event Screen
Gabriel Hush

PG1

Gabriel Soul
Gabriel Soul Solange
Gabriel Thrill
Gabriel Twist
Gabriel Twist Melange
Gabriel Xpress (2,0)
Kvadrat Floyd Screen

MOUNTING

Suspension with wooden beam 4 pcs (standard)

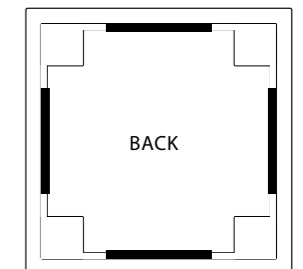

Wooden beam wall 1 pcs



Suspension with magnets 4 pcs (optional)

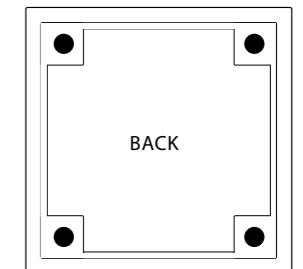

HERTZ

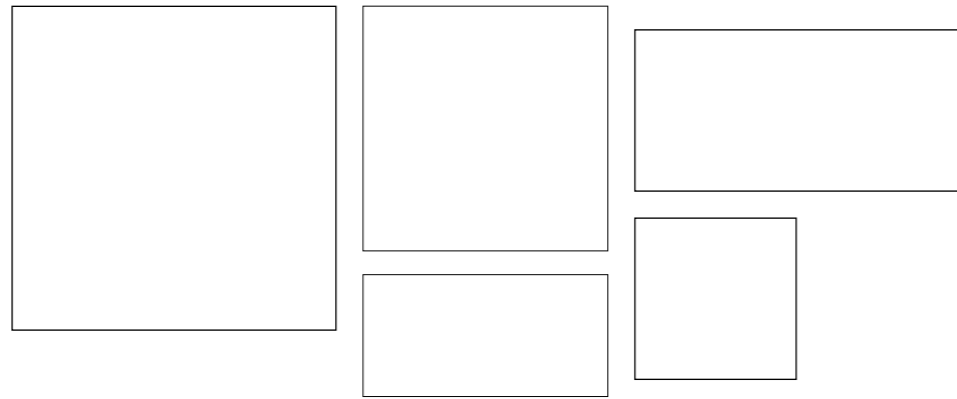

| | | | | | |
|-------------|--------|--------|-------|--------|--------|
| HEIGHT | 80 CM | 80 CM | 60 CM | 60 CM | 40 CM |
| WIDTH | 80 CM | 40 CM | 60 CM | 30 CM | 40 CM |
| TOTAL DEPTH | 5 CM | 5 CM | 5 CM | 5 CM | 5 CM |
| WEIGHT | 5,2 KG | 2,7 KG | 3 KG | 1,2 KG | 1,2 KG |

MATERIAL

Ecophon Inside
Back piece in MDF-board
Suspension with wooden beam is standard
Fabric

OPTIONS

Magnets for mounting, neodym 4 x ø20 x 6 mm
200 cm wooden beam when installing several panels in width
(not in combination with magnets)

ACOUSTIC PROPERTIES

Frequency in Hz

| | | | | | | | |
|------|------|------|------|------|------|------|------|
| 63 | 125 | 250 | 500 | 1000 | 2000 | 4000 | Aw |
| 0,02 | 0,17 | 0,62 | 1,16 | 1,16 | 1,09 | 1,01 | 0,95 |

Absorption Class A

Tested according to ISO 354 och ISO 11654

FIRE TEST

Hertz is tested according to SS-EN ISO 11925-2

UPHOLSTERY MATERIAL

The fabrics for our sound absorbers are carefully selected and tested according to the standard set by all the manufacturers.

PG0

Camira Cara
Camira Carlow
Camira Fiji
Gabriel Event Screen
Gabriel Hush

PG1

Gabriel Soul
Gabriel Soul Solange
Gabriel Thrill
Gabriel Twist
Gabriel Twist Melange
Gabriel Xpress (2,0)
Kvadrat Floyd Screen



CHESTERFIELD / LOOP/ ROMB FRAME FAMILY

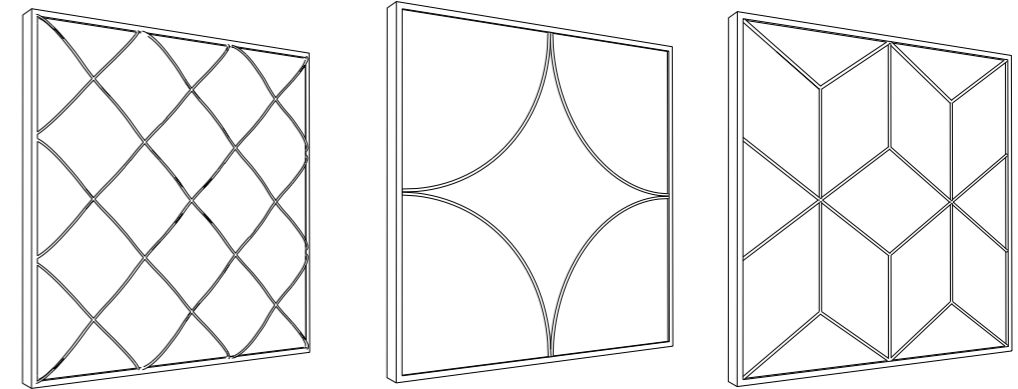

| | |
|--------|---------|
| HEIGHT | 60,5 CM |
| WIDTH | 60,5 CM |
| DEPHT | 6 CM |
| WEIGHT | 7 KG |

MATERIAL

Ecophon Inside
Metal frame in selectable RAL color
Wire grids
Back piece in MDF-board
Suspension with wooden beam is standard
Fabric

OPTIONS

Magnets for mounting, Rubber-coated neodym 4 x ø45 x 6 mm.
200 cm wooden beam when installing several panels in width
(not in combination with magnets)

ACOUSTIC PROPERTIES

Frequency in Hz

| | | | | | | | |
|------|------|------|------|------|------|------|----|
| 63 | 125 | 250 | 500 | 1000 | 2000 | 4000 | Aw |
| 0,03 | 0,19 | 0,62 | 1,11 | 1,19 | 1,13 | 1,1 | 1 |

Absorption Class A

Tested according to ISO 354 och ISO 11654

FIRE TEST

Chesterfield / Loop / Romb is tested according to SS-EN ISO 11925-2

UPHOLSTERY MATERIAL

The fabrics for our sound absorbers are carefully selected and tested according to the standard set by all the manufacturers.

PG0

Camira Cara
Camira Carlow
Camira Fiji
Gabriel Event Screen
Gabriel Hush

PG1

Gabriel Soul
Gabriel Soul Solange
Gabriel Thrill
Gabriel Twist
Gabriel Twist Melange
Gabriel Xpress (2,0)
Kvadrat Floyd Screen



MOUNTING

Suspension with wooden beam 4 pcs (standard)

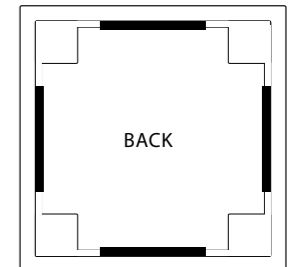

Wooden beam wall 1 pcs



Suspension with magnets 4 pcs (optional)

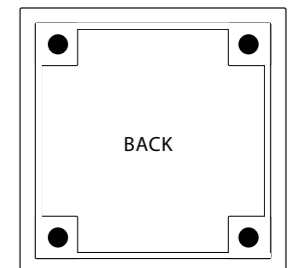

ILLUSION 60 / 120

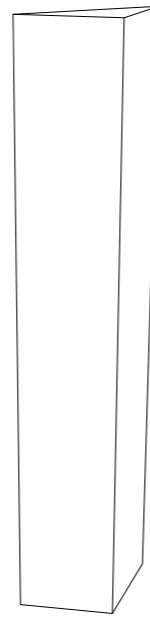
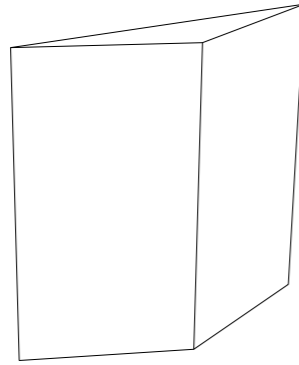

HEIGHT 60 CM
WIDTH 60 CM
DEPTH 12 CM
WEIGHT 2,7 KG

HEIGHT 120 CM
WIDTH 30 CM
DEPTH 12 CM
WEIGHT 2,7 KG

MATERIAL

Ecophon Inside
Back piece in MDF-board
Suspension with wooden beam is standard
Fabric

OPTIONS

Magnets for mounting, neodym 4 x ø20 x 6 mm
200 cm wooden beam when installing several panels in width
(not in combination with magnets)

ACOUSTIC PROPERTIES

Frequency in Hz

| 63 | 125 | 250 | 500 | 1000 | 2000 | 4000 | Aw |
|------|------|------|------|------|------|------|----|
| 0,03 | 0,19 | 0,61 | 1,02 | 1,02 | 1,12 | 1,16 | 1 |

Absorption Class A

Tested according to ISO 354 och ISO 11654

FIRE TEST

Illusion is tested according to SS-EN ISO 11925-2

UPHOLSTERY MATERIAL

The fabrics for our sound absorbers are carefully selected and tested according to the standard set by all the manufacturers.

PG0

Camira Cara
Camira Carlow
Camira Fiji
Gabriel Event Screen
Gabriel Hush

PG1

Gabriel Soul
Gabriel Soul Solange
Gabriel Thrill
Gabriel Twist
Gabriel Twist Melange
Gabriel Xpress (2,0)
Kvadrat Floyd Screen

MOUNTING

Suspension with wooden beam 4 pcs (standard)

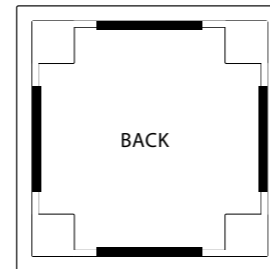

Wooden beam wall 1 pcs



Suspension with magnets 4 pcs (optional)

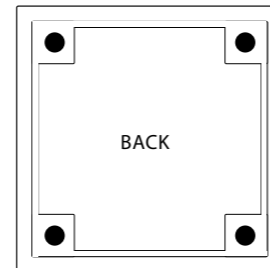

POST

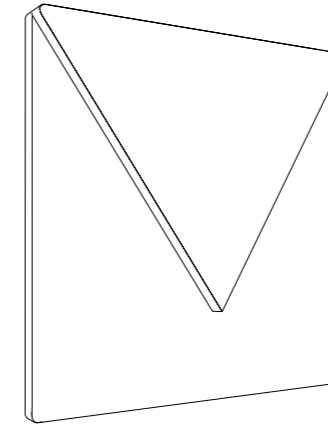

HEIGHT 59,5 CM
WIDTH 59,5 CM
DEPTH 6 CM
WEIGHT 3,8 KG

MATERIAL

Ecophon Inside
Back piece in MDF-board
Suspension with wooden beam is standard
Fabric

OPTIONS

Magnets for mounting, neodym 4 x ø20 x 6 mm
200 cm wooden beam when installing several panels in width
(not in combination with magnets)

ACOUSTIC PROPERTIES

Frequency in Hz

| 63 | 125 | 250 | 500 | 1000 | 2000 | 4000 | Aw |
|------|------|------|------|------|------|------|------|
| 0,02 | 0,17 | 0,62 | 1,16 | 1,16 | 1,09 | 1,01 | 0,95 |

Absorption Class A

Tested according to ISO 354 och ISO 11654

FIRE TEST

Post is tested according to SS-EN ISO 11925-2

UPHOLSTERY MATERIAL

The fabrics for our sound absorbers are carefully selected and tested according to the standard set by all the manufacturers.

PG0

Camira Cara
Camira Carlow
Camira Fiji
Gabriel Event Screen
Gabriel Hush

PG1

Gabriel Soul
Gabriel Soul Solange
Gabriel Thrill
Gabriel Twist
Gabriel Twist Melange
Gabriel Xpress (2,0)
Kvadrat Floyd Screen

MOUNTING

Suspension with wooden beam 4 pcs (standard)

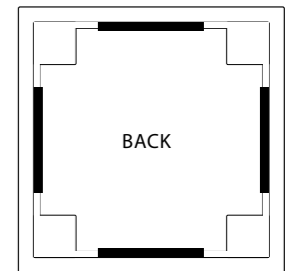

Wooden beam wall 1 pcs



Suspension with magnets 4 pcs (optional)

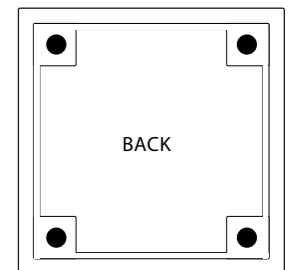

CLAMP WALL SQUARE / ROUND

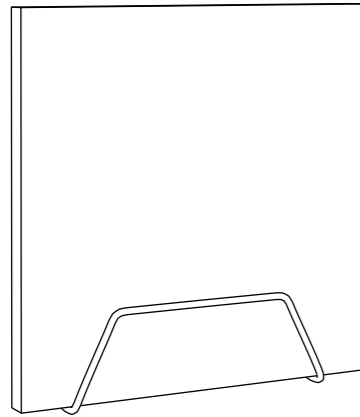

HEIGHT 59,5/79,5 CM
 WIDTH 59,5/79,5 CM
 DEPTH 4 CM
 TOTAL DEPTH 6 CM
 TOTAL WEIGHT 2,6/5,2 KG

DIAMETER ø60/80 CM
 WIDTH 4 CM
 TOTAL DEPTH 6 CM
 TOTAL WEIGHT 2,8/3,6 KG

MATERIAL
 Ecophon Inside
 Fabric
 Metal frame in selectable RAL color

ACOUSTIC PROPERTIES

| Frequency in Hz | | | | | | | |
|-----------------|------|------|------|------|------|------|------|
| 63 | 125 | 250 | 500 | 1000 | 2000 | 4000 | Aw |
| 0,02 | 0,17 | 0,62 | 1,16 | 1,16 | 1,09 | 1,01 | 0,95 |

Absorption Class A

Tested according to ISO 354 och ISO 11654

FIRE TEST

Clamp is tested according to SS-EN ISO 11925-2

UPHOLSTERY MATERIAL

The fabrics for our sound absorbers are carefully selected and tested according to the standard set by all the manufacturers.

PG0
 Camira Cara
 Camira Carlow
 Camira Fiji
 Gabriel Event Screen
 Gabriel Hush

PG1
 Gabriel Soul
 Gabriel Soul Solange
 Gabriel Thrill
 Gabriel Twist
 Gabriel Twist Melange
 Gabriel Xpress (2,0)
 Kvadrat Floyd Screen



CLAMP FLOOR

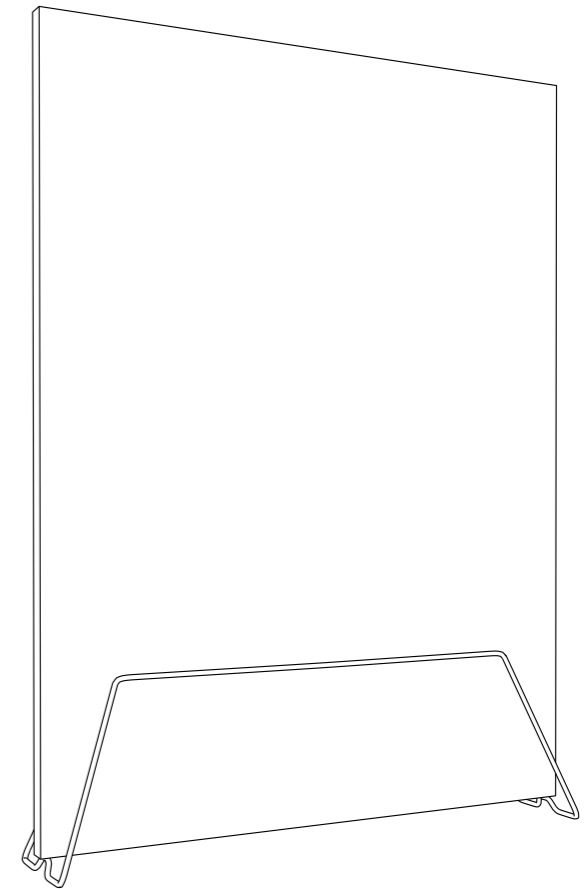

HEIGHT 170 CM
 WIDTH 120 CM
 DEPTH 4,8 CM
 TOTAL DEPTH 45 CM
 WEIGHT 7,4 KG
 FRAME WEIGHT 4,6 KG

MATERIAL
 Ecophon Inside
 Fabric
 Metal frame in selectable RAL color

ACOUSTIC PROPERTIES

| Frequency in Hz | | | | | | | |
|-----------------|------|------|------|------|------|------|-----|
| 63 | 125 | 250 | 500 | 1000 | 2000 | 4000 | N10 |
| 0,07 | 0,63 | 1,43 | 2,61 | 2,87 | 2,46 | 2,19 | 4,5 |

Absorption Class A

Tested according to ISO 354 och SS 25269

FIRE TEST

Clamp is tested according to SS-EN ISO 11925-2

UPHOLSTERY MATERIAL

The fabrics for our sound absorbers are carefully selected and tested according to the standard set by all the manufacturers.

PG0
 Camira Cara
 Camira Carlow
 Camira Fiji
 Gabriel Event Screen
 Gabriel Hush

PG1
 Gabriel Soul
 Gabriel Soul Solange
 Gabriel Thrill
 Gabriel Twist
 Gabriel Twist Melange
 Gabriel Xpress (2,0)
 Kvadrat Floyd Screen



CLAMP CEILING

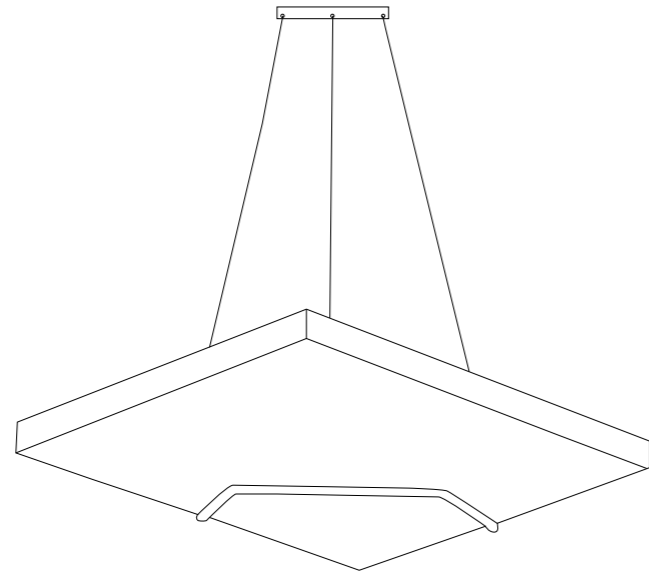

| | |
|--------------|---------|
| HEIGHT | 59,5 CM |
| WIDTH | 59,5 CM |
| DEPHT | 4,5 CM |
| TOTAL DEPTH | 6,5 CM |
| TOTAL WEIGHT | 3,6 KG |

| | |
|--------------|---------|
| HEIGHT | 79,5 CM |
| WIDTH | 79,5 CM |
| DEPHT | 4,5 CM |
| TOTAL DEPTH | 6,5 CM |
| TOTAL WEIGHT | 6,6 KG |

MATERIAL

Ecophon Inside
Fabric
Metal clamp for ceiling in selectable RAL color
Wire 80 cm / 150 cm
Adjustable cable lock with hook
Ceiling fastener in selectable RAL color

ACOUSTIC PROPERTIES

| Frequency in Hz | 63 | 125 | 250 | 500 | 1000 | 2000 | 4000 | Aw |
|-----------------|------|------|------|------|------|------|------|------|
| | 0,02 | 0,17 | 0,62 | 1,16 | 1,16 | 1,09 | 1,01 | 0,95 |

Absorption Class A

Tested according to ISO 354 och ISO 11654

FIRE TEST

Clamp is tested according to SS-EN ISO 11925-2

UPHOLSTERY MATERIAL

The fabrics for our sound absorbers are carefully selected and tested according to the standard set by all the manufacturers.

PG0

Camira Cara
Camira Carlow
Camira Fiji
Gabriel Event Screen
Gabriel Hush

PG1

Gabriel Soul
Gabriel Soul Solange
Gabriel Thrill
Gabriel Twist
Gabriel Twist Melange
Gabriel Xpress (2,0)
Kvadrat Floyd Screen

MOUNTING

Metal clamp 1 pcs

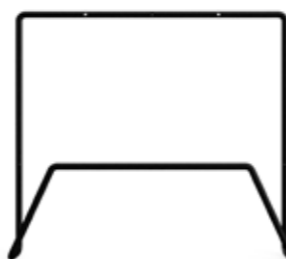

Wire 3 pcs 80 cm / 150 cm
Adjustable cable lock with hook 3 pcs

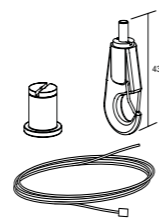

Ceiling bracket 1 pcs

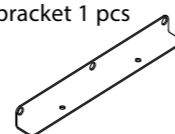

MÖBELFAKTA



CUBIC 16/32

| | | |
|--------|--------|--------|
| HEIGHT | 100 CM | 200 CM |
| WIDTH | 40 CM | 40 CM |
| DEPHT | 40 CM | 40 CM |
| WEIGHT | 17 kg | 23 kg |

MATERIAL

Ecophon Inside
Wooden shell
Fabric Gabriel Xpress
With wheels for easy placement
Top / bottom in metal, with optional RAL-colour, black or white finish

FIRE TEST

Will be tested shortly

ACOUSTIC PROPERTIES

The absorbent placed in the middle of the room

| Frequency in Hz | 63 | 125 | 250 | 500 | 1000 | 2000 | 4000 | N10 |
|-----------------|-----|------|-----|------|------|------|------|-----|
| | 0,4 | 1,34 | 2,0 | 2,59 | 3,18 | 3,24 | 3,22 | 3,8 |

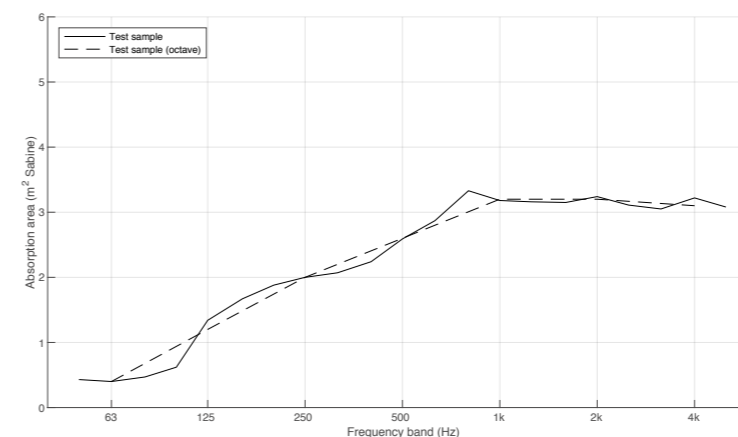

The absorbent placed in a corner (bass trap).

| Frequency in Hz | 63 | 125 | 250 | 500 | 1000 | 2000 | 4000 | N10 |
|-----------------|------|------|------|------|------|------|------|-----|
| | 0,49 | 2,09 | 1,97 | 2,10 | 2,04 | 1,86 | 1,75 | 5,6 |

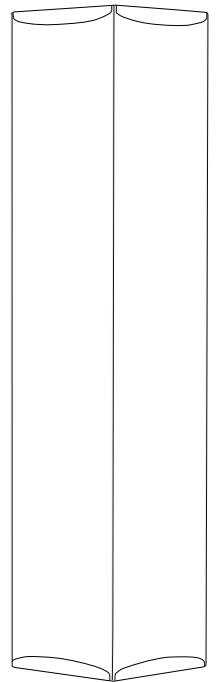
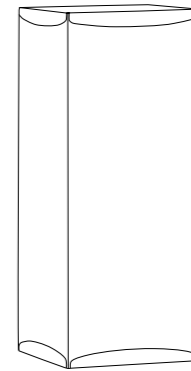
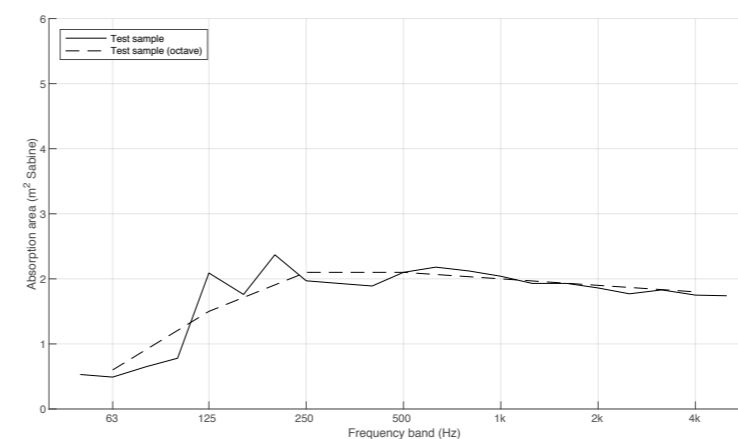

LEAVES

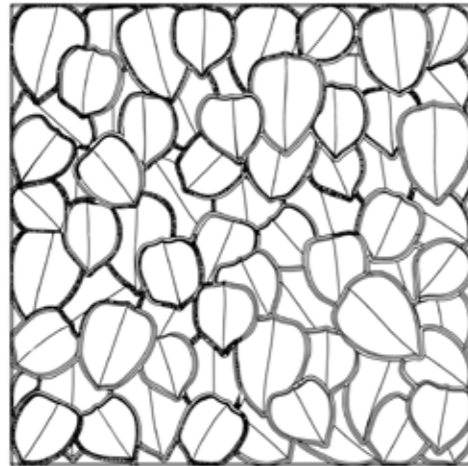

HEIGHT 60,5 CM
 WIDTH 60,5 CM
 DEPTH 6,6 CM
 WEIGHT 0,9 KG
 AREA 0,36 M²
 VOLUME 0,038 M³

MATERIAL

Polyester
 Felt black / dark grey / light grey / offwhite
 Fabric Blazer / Europost
 Magnets for mounting, 4 x ø30 x 6 mm

ACOUSTIC PROPERTIES

Frequency in Hz

| 63 | 125 | 250 | 500 | 1000 | 2000 | 4000 | Aw |
|-----|-----|-----|-----|------|------|------|-----|
| 0,0 | 0,1 | 0,5 | 1,0 | 0,9 | 0,9 | 1,0 | 0,6 |

Absorption Class C

Tested according to ISO 354:2003, ISO 25269:2013, ISO 11654:1997

FIRE TEST

Tested according to EN ISO 11925-2



BEEHIVE RECTANGULAR

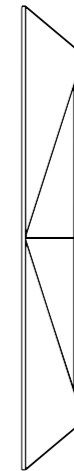
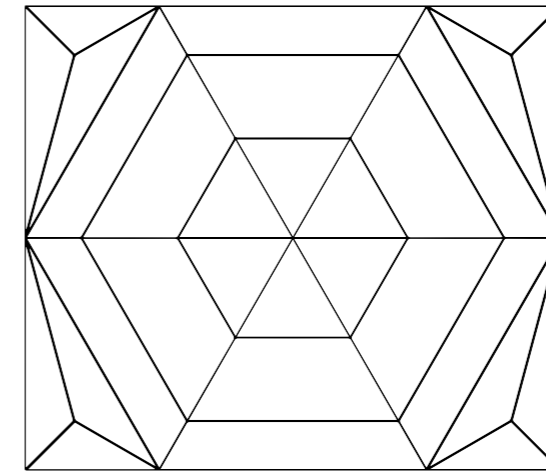

HEIGHT 55 CM
 WIDTH 47,5 CM
 DEPTH 7,5 CM
 WEIGHT 0,8 KG
 AREA 0,26 M²
 VOLUME 0,032 M³

MATERIAL

Polyester
 Felt black / dark grey / light grey / offwhite
 Fabric Blazer / Europost
 Magnets for mounting, 4 x ø30 x 6 mm

ACOUSTIC PROPERTIES

Frequency in Hz

| 63 | 125 | 250 | 500 | 1000 | 2000 | 4000 | Aw |
|-----|-----|-----|-----|------|------|------|-----|
| 0,0 | 0,1 | 0,5 | 1,0 | 0,9 | 0,9 | 1,0 | 0,6 |

Absorption Class C

Tested according to ISO 354:2003, ISO 25269:2013, ISO 11654:1997

FIRE TEST

Tested according to EN ISO 11925-2

MOUNTING

Magnets for mounting 4 pcs

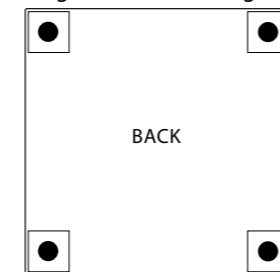

MOUNTING

Magnets for mounting 4 pcs

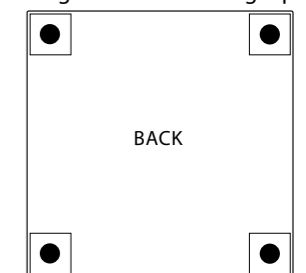

BEEHIVE

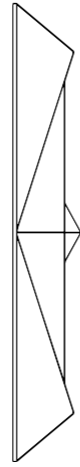
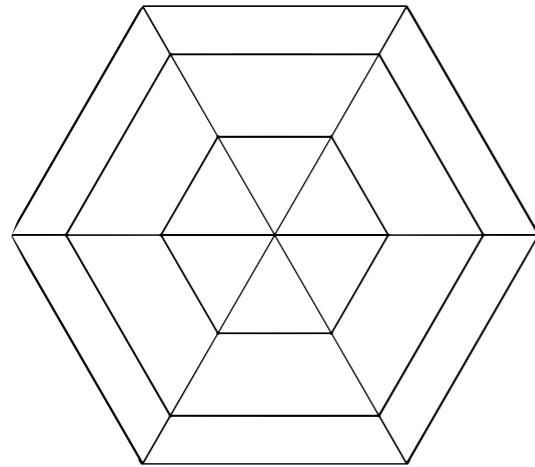

HEIGHT 55 CM
 WIDTH 47,5 CM
 DEPTH 7,5 CM
 WEIGHT 0,5 KG
 AREA 0,26 M²
 VOLUME 0,027 M³

MATERIAL
 Polyester
 Felt black / dark grey / light grey / offwhite
 Fabric Blazer / Europost
 Magnets for mounting, 2 x ø30 x 6 mm

ACOUSTIC PROPERTIES

| Frequency in Hz | | | | | | | |
|-----------------|-----|-----|-----|------|------|------|-----|
| 63 | 125 | 250 | 500 | 1000 | 2000 | 4000 | Aw |
| 0,0 | 0,1 | 0,5 | 1,0 | 0,9 | 0,9 | 1,0 | 0,6 |

Absorption Class C

Tested according to ISO 354:2003, ISO 25269:2013, ISO 11654:1997

FIRE TEST

Tested according to EN ISO 11925-2

MOUNTING

Magnets for mounting 2 pcs

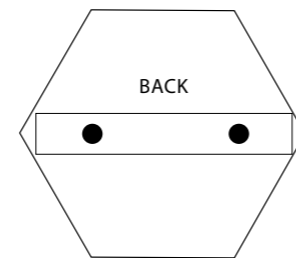

RACE WALL

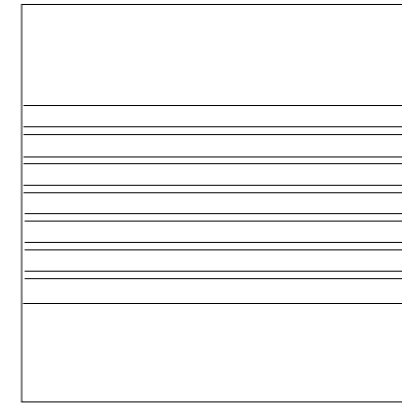

STRAIGHT

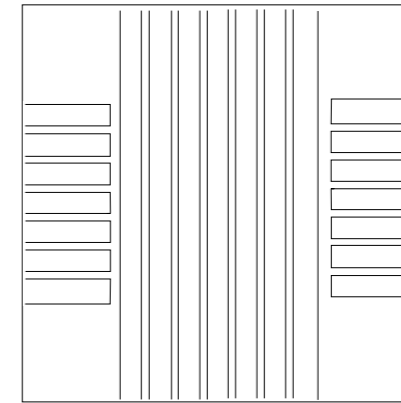

CROSS

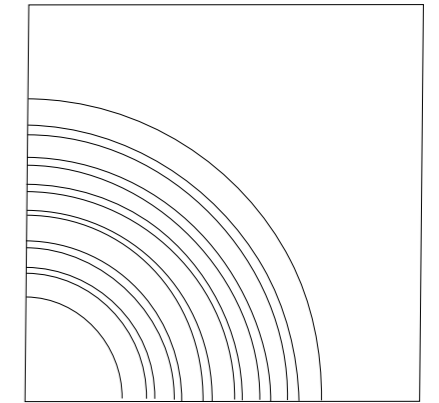

CURVE

HEIGHT 60,5 CM
 WIDTH 60,5 CM
 DEPTH 7,5 CM
 WEIGHT 0,9 KG
 AREA 0,36 M²
 VOLUME 0,038 M³

MATERIAL
 Polyester
 Felt black / dark grey / light grey / offwhite
 Fabric Blazer / Europost
 Magnets for mounting, 4 x ø30 x 6 mm

ACOUSTIC PROPERTIES

| Frequency in Hz | | | | | | | |
|-----------------|-----|-----|-----|------|------|------|-----|
| 63 | 125 | 250 | 500 | 1000 | 2000 | 4000 | Aw |
| 0,0 | 0,1 | 0,5 | 1,0 | 0,9 | 0,9 | 1,0 | 0,6 |

Absorption Class C

Tested according to ISO 354:2003, ISO 25269:2013, ISO 11654:1997

FIRE TEST

Tested according to EN ISO 11925-2

MOUNTING

Magnets for mounting 4 pcs

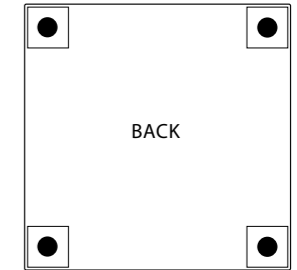

MOON

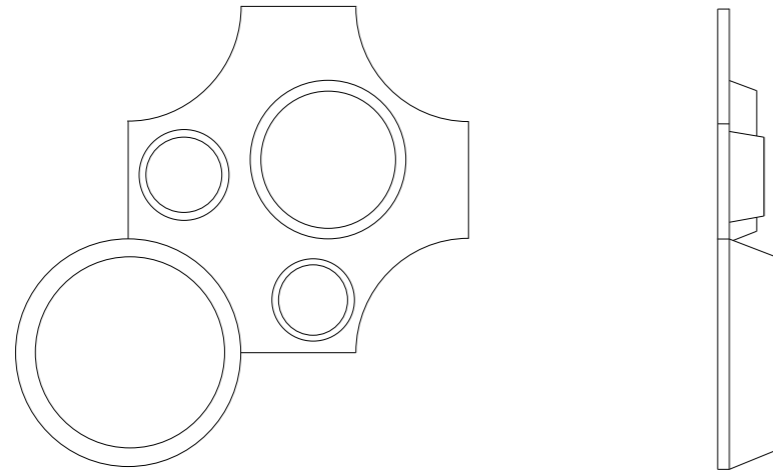

HEIGHT 90 CM
 WIDTH 55 CM
 DEPTH 9 CM
 WEIGHT 0,9 KG
 AREA 0,36 M²
 VOLUME 0,064 M³

MATERIAL

Polyester
 Felt black / dark grey / light grey / offwhite
 Fabric Blazer / Europost
 Magnets for mounting, 3 x ø30 x 6 mm

ACOUSTIC PROPERTIES

| Frequency in Hz | | | | | | | |
|-----------------|-----|-----|-----|------|------|------|-----|
| 63 | 125 | 250 | 500 | 1000 | 2000 | 4000 | Aw |
| 0,0 | 0,1 | 0,5 | 1,0 | 0,9 | 0,9 | 1,0 | 0,6 |

Absorption Class C

Tested according to ISO 354:2003, ISO 25269:2013, ISO 11654:1997

FIRE TEST

Tested according to EN ISO 11925-2

MOUNTING

Magnets for mounting 3 pcs

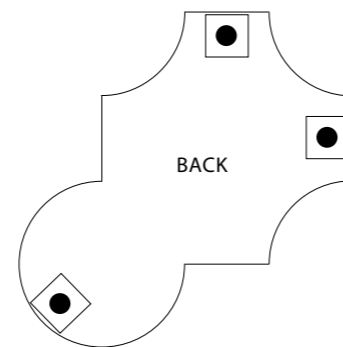

PEBBLE

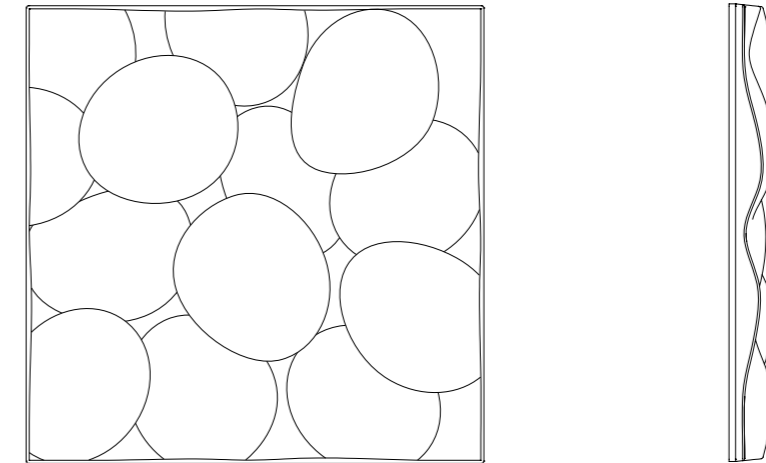

HEIGHT 60,5 CM
 WIDTH 60,5 CM
 DEPTH 7,5 CM
 WEIGHT 0,9 KG
 AREA 0,36 M²
 VOLUME 0,038 M³

MATERIAL

Polyester
 Felt black / dark grey / light grey / offwhite
 Fabric Blazer / Europost
 Magnets for mounting, 4 x ø30 x 6 mm

ACOUSTIC PROPERTIES

| Frequency in Hz | | | | | | | |
|-----------------|-----|-----|-----|------|------|------|-----|
| 63 | 125 | 250 | 500 | 1000 | 2000 | 4000 | Aw |
| 0,0 | 0,1 | 0,5 | 1,0 | 0,9 | 0,9 | 1,0 | 0,6 |

Absorption Class C

Tested according to ISO 354:2003, ISO 25269:2013, ISO 11654:1997

FIRE TEST

Tested according to EN ISO 11925-2

MOUNTING

Magnets for mounting 4 pcs

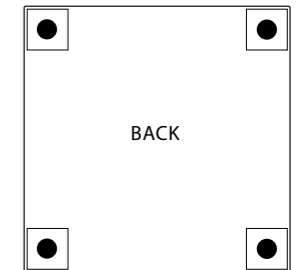

CROPFIELD

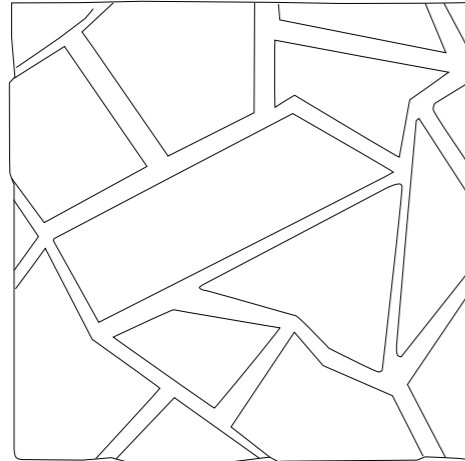

HEIGHT 60,5 CM
 WIDTH 60,5 CM
 DEPTH 5,5 CM
 WEIGHT 0,9 KG
 AREA 0,36 M²
 VOLUME 0,038 M³

MATERIAL

Polyester
 Felt black / dark grey / light grey / offwhite
 Fabric Blazer / Europost
 Magnets for mounting, 4 x ø30 x 6 mm

ACOUSTIC PROPERTIES

Frequency in Hz

| 63 | 125 | 250 | 500 | 1000 | 2000 | 4000 | Aw |
|-----|-----|-----|-----|------|------|------|-----|
| 0,0 | 0,1 | 0,5 | 1,0 | 0,9 | 0,9 | 1,0 | 0,6 |

Absorption Class C

Tested according to ISO 354:2003, ISO 25269:2013, ISO 11654:1997

FIRE TEST

Tested according to EN ISO 11925-2

MOUNTING

Magnets for mounting 4 pcs

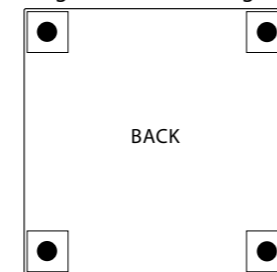

RIB WALL

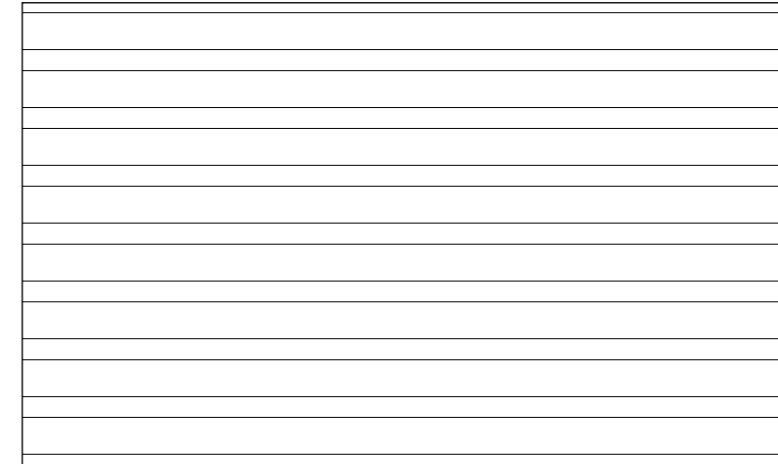

HEIGHT 60 CM
 WIDTH 100 CM
 DEPTH 1,5 CM
 WEIGHT 2,5 KG
 AREA 0,6 M²
 VOLUME 0,06 M³

MATERIAL

Polyester
 Felt black / dark grey / light grey / offwhite
 Fabric Blazer / Europost
 Magnets for mounting, 6 x ø30 x 6 mm

ACOUSTIC PROPERTIES

Frequency in Hz

| 63 | 125 | 250 | 500 | 1000 | 2000 | 4000 | Aw |
|-----|-----|-----|-----|------|------|------|-----|
| 0,0 | 0,1 | 0,5 | 1,0 | 0,9 | 0,9 | 1,0 | 0,6 |

Absorption Class C

Tested according to ISO 354:2003, ISO 25269:2013, ISO 11654:1997

FIRE TEST

Tested according to EN ISO 11925-2

MOUNTING

Magnets for mounting 6 pcs

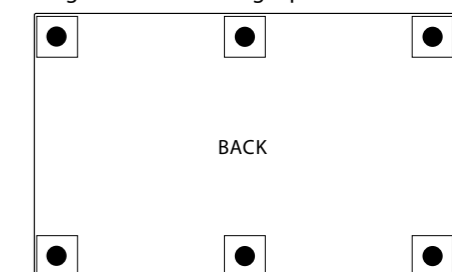



CAD/BIM

Most of our products are downloadable as CAD/BIM objects for 3ds Max, Archicad, AutoCad 2D, DWG, AutoCad 3D, Material & Textures, Revit, SketchUp and pCon Planner.

pCon

The perfect tool for managing everything from simple floor plans to the most complex 3D renderings, Thanks to pCon, producing customised solutions for your project has never been simpler. Powerful OFML data facilitates the entire configuration process from dimensions to the final price. Decibel by Johanson has many years' experience of preparing complete offers for our products.

If you are in need of any files in order to plan your design, please don't hesitate to contact us at Decibel.

SUSTAINABILITY – A KEY PART OF OUR CONCEPT

Decibel by Johanson is tireless in its efforts to create new possibilities and improve the qualities of its products from a sustainability perspective. We place great emphasis on ethical, sustainable production and good working conditions, both in our own facilities and those of our suppliers.

CUS ON ALL COMPONENTS

For all products bearing the Ecophon Inside label our partner and supplier is Ecophon, a company that takes sustainability very seriously and is able to account for the materials' environmental impact. More than 70 percent of the sound-absorbing glass wool core is made from recycled glass. (In a process that is unique in the world, glass bottles deposited in recycling stations in Sweden are recycled as sound absorbers.)

Ecophon was the first in the market to offer a product range made with a plant-based binder, saving the equivalent of 24,000 barrels of crude oil per year. Ecophon products also have a number of third-party certificates that ensure a healthy indoor environment. The production plant in Hyllinge in the south of Sweden

is powered by electricity from 100% renewable sources.

All our design panels are made of pressed polyester felt from recycled PET bottles.

COVERINGS

The fabrics used in our sound absorbers are carefully selected and tested by the manufacturers in accordance with relevant standards.

Decibel aims to ensure that none of the properties of the various components are altered or compromised in any way.

MÖBELFAKTA

The majority of our products meet strict Möbel fakta criteria. This comprehensive and updated reference and labelling system is synonymous with professionalism and quality throughout the entire value chain, all the way to the end user. The system is based on three areas of requirements:

- Quality
- Environment
- Social responsibility

Roltrade



Oy Roltrade Ab
Itälahdenkatu 18 A 5. krs.
00210 Helsinki
Puh. 010 322 0500
roltrade@roltrade.com
www.roltrade.com

DECIBEL BY JOHANSON – SOUND ABSORBERS THAT MAKE A CLEAR DIFFERENCE

Our products are developed not only with people's ears in mind – they are designed to have eye-appeal as well. We want our sound absorbers to be as attractive to look at as they are effective in creating a pleasant acoustic environment. The visual design and acoustic properties work together to produce the kind of truly harmonious setting that helps promote a sense of well-being and improves productivity.

DECIBEL
by JOHANSON

www.decibelab.se